

Nellcor™

OxiMax N-600x Pulse Oximeter

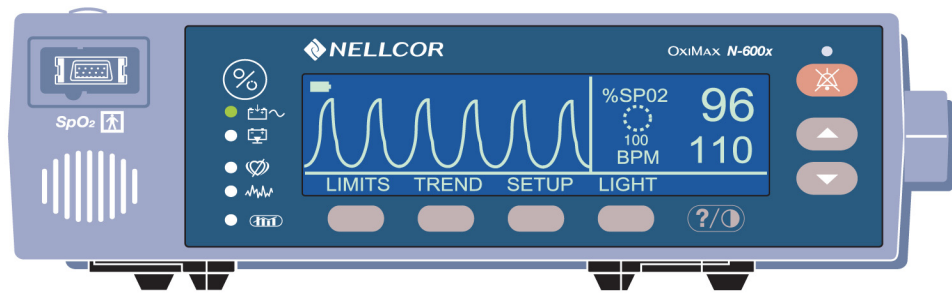

COVIDIEN, COVIDIEN with logo, the Covidien logo and *positive results for life* are U.S. and internationally registered trademarks of Covidien AG. Other brands are trademarks of a Covidien company. ©2011 Covidien.

U.S. Patents 5,485,847; 5,676,141; 5,743,263; 6,035,223; 6,226,539; 6,411,833; 6,463,310; 6,591,123; 6,708,049; 7,016,715; 7,039,538; 7,120,479; 7,120,480; 7,142,142; 7,162,288; 7,190,985; 7,194,293; 7,209,774; 7,212,847; 7,400,919.

To obtain information about a warranty, if any, contact Covidien Technical Services at 1.800.635.5267 or your local representative.

Purchase of this instrument confers no express or implied license under any Covidien patent to use the instrument with any pulse oximeter that is not manufactured or licensed by Covidien.

Contents

Introduction	1
Warnings	1
Cautions	3
Overview	4
Monitor Description	4
Front Panel	5
Rear Panel	6
Softkey Menu	6
Related Documents	10
Routine Maintenance	11
Cleaning the Monitor	11
Periodic Safety Checks	12
Functional Checks	12
Battery Operation	13
Performance Verification	15
Overview	15
Required Equipment	15
Performance Tests	16
Battery Charge	16
Power-Up Performance	16
Operational Setup	22
General Operation	29
Pulse Oximetry Functional Tests	32
Safety Tests	46
Power-On Settings and Service Functions	47
Overview	47
Adjusting the Power-On Settings	47
Factory Default Settings	48
Neonate Default Settings	48
Adult Default Settings	50
Service Functions	51
Accessing the Service Functions	51
Exit Softkey	52
Next Softkey	52
Param Softkey Menu	53
Print Softkey Menu	54
Next Softkey Menu	58
Setting Institutional Defaults (Sample)	61
Troubleshooting	63
Overview	63
Performing Repairs	63
Problem Resolution	63
Power	65
Buttons	66
Display/Alarms	67

Operational Performance	68
Data Port	69
On-Screen Help	70
Accessing Multiple Topics	70
Accessing Single Topics	72
Error Codes	74
Additional Messages	80
Primary Speaker Failure	81
Disassembling the Monitor	83
Overview	83
Replacement Level	84
Replacing the Fuse	84
Disassembling the Monitor	85
Assembling the Monitor	88
Battery Replacement	88
Removing the Old Battery	88
Replacing the Battery	89
Power Entry Module (PEM) Replacement	90
Removing the Power Entry Module	90
Replacing the Power Entry Module	91
Power Supply Replacement	91
Removing the Power Supply	91
Replacing the Power Supply	92
Cooling Fan Replacement	93
Removing the Cooling Fan	93
Replacing the Cooling Fan	94
Display PCB Replacement	95
Removing the Display PCB	95
Replacing the Display PCB	96
Main Board PCB Replacement	97
Removing the Main Board PCB	97
Replacing the Main Board PCB	98
Alarm Speaker Replacement	99
Removing the Alarm Speaker	99
Replacing the Alarm Speaker	101
Top Case Assembly Replacement	102
Removing the Top Case Assembly	102
Replacing the Top Case Assembly	102
Spare Parts	103
Overview	103
Ordering Replacement Parts	103
Spare Parts List	104
Packing for Shipment	107
Overview	107
Returning the Monitor	107
Repacking the Monitor Using the Original Carton	108
Repacking the Monitor Using a Generic Carton	109
Specifications	111
Performance	111
Electrical Requirements	112

Environmental Conditions	114
Physical Characteristics	115
Compliance	115
Manufacturer's Declaration	117
Safety Tests	124
Ground Integrity	124
Earth Leakage Current	124
Enclosure Leakage Current	124
Patient Applied Risk Current	125
Patient Isolation Risk Current	125
Data Port Interface Protocol	127
Overview	127
Configuring the Data Port	127
Communication Baud Rate	128
Communication Protocol	129
Language Selection	131
Nurse Call Setup	132
Analog Calibration Setup	133
Philips Communications	133
GE Marquette Communications	134
Datex-Ohmeda AS/3 Communications	135
Connecting to the Data Port	136
Communicating with a Computer	137
Dump Instrument Info (Option 1)	137
Set Date and Time (Option 2)	138
Dump Trend (Option 3)	138
Dump Error Log (Option 4)	138
Exit Interactive Mode (Option 5)	138
Using Data on the Computer	139
Real-Time Printout	139
Column Heading	141
Patient Data and Operating Status	142
Trend Data Printout (ASCII Mode)	144
Trend Printout (Graph Mode)	145
Nurse Call	145
Analog Output	146
Technical Discussion	147
Oximetry Overview	147
Functional versus Fractional Saturation	148
Measured versus Calculated Saturation	148
SatSeconds Alarm Management	149
Signal Processing	149
OXIMAX Technology	149
Block Diagram Theory	150
Index	177

Introduction

Warnings



Warnings are identified by the WARNING symbol shown above.

Warnings alert the user to potential serious outcomes (death, injury, or adverse events) to the patient or user.



WARNING: The sensor extrapolates from the date and time provided by the *N-600x* when recording the sensor event record to the sensor. The accuracy of the date and time is the responsibility of the *N-600x*. It is recommended that the *N-600x* user set the date and time to the correct value before a sensor event record-enabled sensor is connected, and that this date and time not be changed while the sensor remains connected. Since a sensor with sensor event record data can be transported from one monitor to another, having discrepancies in the date and time between monitors and the sensor event record data will affect the order the sensor event record data appears. To eliminate this possible problem, all monitors within an institution should be set to the same time.



WARNING: Explosion Hazard - Do not use the *N-600x* pulse oximeter in the presence of flammable anesthetics.



WARNING: Do not spray, pour, or spill any liquid on the *N-600x*, its accessories, connectors, switches, or openings in the chassis as this may damage the pulse oximeter.



WARNING: Before attempting to open or disassemble the *N-600x*, disconnect the power cord to avoid possible injury.



WARNING: The LCD panel contains toxic chemicals. Do not ingest chemicals from a broken LCD panel.



WARNING: The use of accessories, sensors, and cables other than those specified may result in increased emission and/or decreased immunity of the *N-600x* pulse oximeter.



WARNING: Do not silence or decrease the volume of the *N-600x* audible alarm if patient safety could be compromised.



WARNING: Pressing ALARM SILENCE will keep ALL alarms from sounding for the alarm silence duration period.



WARNING: When installing the monitor's AC power cord, ensure the cord is carefully positioned to prevent tripping and entanglement.

Cautions



Cautions are identified by the CAUTION symbol shown above.

Cautions alert the user to exercise care necessary for the safe and effective use of the *N-600x* pulse oximeter.



Caution: Observe ESD (electrostatic discharge) precautions when working within the unit.



Caution: Observe ESD (electrostatic discharge) precautions when disassembling and reassembling the *N-600x* and when handling any of the components of the *N-600x*.



Caution: When reassembling the *N-600x*, tighten the screws that hold the cases together (10-in lbs. maximum). Overtightening could strip out the screw holes in the top case, rendering it unusable.



Caution: When installing the power supply or the Main Board PCB, tighten the seven screws (4-in lbs. maximum). Overtightening could strip out the screw holes in the bottom case, rendering it unusable.

Overview

This manual contains information for servicing the Nellcor *OxIMAX N-600x*TM pulse oximeter. Only qualified service personnel should service this product. Before servicing the monitor, please read the *OxIMAX N-600x*TM *Operator's Manual* carefully for safe operation.

Monitor Description

The *N-600x* monitor is intended for the continuous non-invasive monitoring of functional oxygen saturation of arterial hemoglobin (%SpO₂) and pulse rate. The *N-600x* is intended for use with neonatal, pediatric, and adult patients who are well or poorly perfused, in hospitals, hospital-type facilities, intra-hospital transport, and home environments. For prescription use only.



Note: Hospital use typically covers such areas as general care floors, operating rooms, special procedure areas, intensive and critical care areas, within the hospital plus hospital-type facilities. Hospital-type facilities include physician office based facilities, sleep labs, skilled nursing facilities, surgicenters, and sub-acute centers.

Intra-hospital transport includes transport of a patient within the hospital or hospital-type facility.

Homecare use is defined as managed/used by a lay person (parent or other similar non-critical caregiver) in the home environment.

Use with any particular patient requires the selection of an appropriate *OxIMAX* oxygen sensor as described in the *OxIMAX N-600x Operator's Manual*.

Through the use of the four softkeys, users can access trend information, select an alarm limit to be changed, choose the language to be used, adjust the internal time clock, and change communications protocol. The monitor can operate on AC power or on an internal battery. The controls and indicators for the *N-600x* are illustrated and identified in Figure 1 and Figure 2.

Front Panel

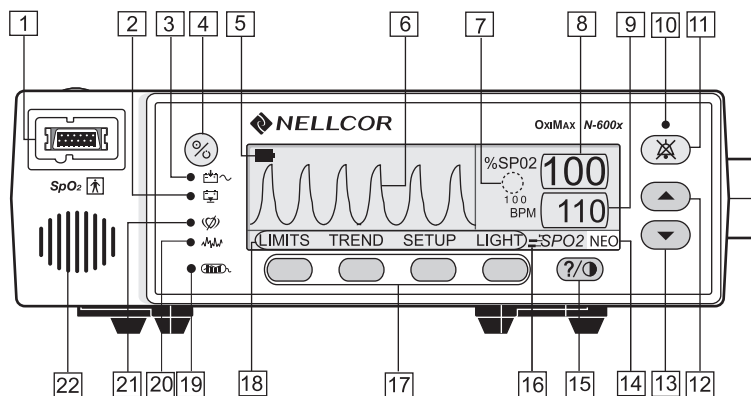

1. SpO2 <i>OxiMAX</i> Sensor Port	12. ADJUST UP Button
2. Low Battery Indicator	13. ADJUST DOWN Button
3. AC Power Indicator	14. Neonate Mode Indicator
4. ON/STANDBY Button	15. HELP/CONTRAST Button
5. Battery Fuel Gauge Indicator	16. Fast Response Mode Indicator
6. Waveform Display	17. Softkeys
7. <i>SatSeconds</i> TM Indicator	18. Menu Bar
8. %SpO2 Display	19. Data In-Sensor Indicator
9. Pulse Rate Display	20. Interference Indicator
10. Alarm Silence Indicator	21. Pulse Search Indicator
11. ALARM SILENCE Button	22. Monitor Speaker

Figure 1: N-600x Front Panel

Rear Panel

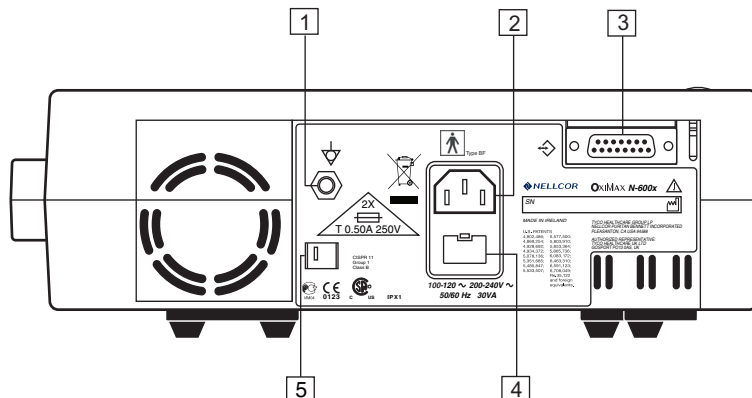

1. Equipotential Terminal (Ground)
2. AC Power Connector
3. Data Port Connector
4. Fuse Holder
5. Supply Voltage Selector Switch

Figure 2: N-600x Rear Panel

Softkey Menu

The monitor's softkey menu hierarchy is outlined below. Choose the type of trend data to view by selecting the Monitor or Sensor trend data in the Trend menu. Sensor sub-menu choices differ depending on what type of patient alarm event data is stored in the sensor chip, such as, event or loop.

The menu structure includes BACK softkey options to return to the previous menu level without exiting the Trend menu entirely. Trend data must be compiled on entry or re-entry to the Trend menu. When the softkeys are available, both BACK and EXIT options are available. The BACK softkey returns to the previous level and the EXIT softkey returns to the Main menu. If only one space is available, the BACK softkey is included, this may require returning one or two levels to access an EXIT softkey.

The BACK and EXIT softkeys are positioned on the right-most softkeys, respectively.

The menu structure below identifies:

- **BOLDFACE TYPE** — softkey title as displayed on the monitor
- Underlined Text — description of the softkey menu item
- *Italicized Text* — the destination of the **BACK** and **EXIT** softkeys

- (Main Menu)
- LIMITS** (Limits Menu)
 - **SELECT**
 - **NEO**
 - **ADULT**
 - **EXIT** (to Main menu)
- TREND** (Trend Menu)
 - **MON** (Monitor Menu)
 - **VIEW** (Monitor Trend View Menu)
 - **DUAL**
 - **SPO2**
 - **PULSE**
 - **NEXT** (History/Amplitude Menu)
 - **HIST** (Delete/Print2 Menu)
 - **DELETE** (delete Trends)
 - **“DELETE TRENDS”**
 - **YES** (return to Main menu)
 - **NO** (back to Delete/Print menu)
 - **PRINT**
 - **BACK** (back to Hist/Amp menu)
 - **EXIT** (to Main menu)
 - **AMP** (Amplitude Menu)
 - **BACK** (back to Hist/Amp menu)
 - **EXIT** (to Main menu)
 - **BACK** (back to Monitor Trend View menu)
 - **EXIT** (to Main menu)
 - **ZOOM** (Monitor Trend Zoom Menu)
 - **TIME** (Cycle through 48h, 36h, 24h, 12h, 8h, 4h, 2h, 1h, 30m, 15m, 40s, 20s for current view)
 - **SCALE** (Cycle through ± 5 , ± 10 , ± 15 , ± 20 , ± 25 , ± 30 , ± 35 , ± 40 and ± 50 (units of BPM or %SpO₂, depending on the data displayed) of the max and min. values under the cursor, default to 10-100 for SAT trend graph and 5-250 for Pulse trend graph if there is no data point under the cursor for current view)
 - **AUTO** (based on all of the graphed trend data: maximum value, rounded up to nearest multiple of 10, minimum value, rounded down to nearest multiple of 10 minus 10)
 - **BACK** (back to Monitor menu)
 - **NEXT** (Delete/Print1 Menu)
 - **DELETE**
 - **“DELETE TRENDS?”**
 - **YES** (to Main menu)
 - **NO** (back to Delete/Print1 menu)
 - **PRINT**
 - **BACK** (back to Monitor menu)
 - **EXIT** (to Main menu)
 - **BACK** (back to Trend menu)
 - **SENSOR** (Sensor/Event Menu)
 - (if event data is in the sensor, the Graph menu, the screen remains in the appropriate state until the next menu selection is made)
 - **GRAPH** (Graph Menu) (display events #1-N, in inverse chronological order; up/down also scroll through events in order)
 - **<** (show previous graph, only available when there is a previous graph)
 - **>** (show next graph, only available when there is a next graph)

- - - **PRINT**
- - - **BACK** (*back to Sensor menu*)
- - **TABLE** (Table Menu)
- - - **^** (*show previous table, only available when there is a previous graph; bottom/top line repeats in new table*)
- - - **v** (*show next table, only available when there is a next graph; bottom/top line repeats in new table*)
- - - **PRINT**
- - - **BACK** (*back to Sensor menu*)
- - **BACK** (*back to Trend menu*)
- - - **EXIT** (*to Main menu*)
- (Sensor/Loop Menu) (*If continuous-Loop data is in the sensor, the following displays*)
- - **VIEW** (Sensor Trend View Menu)
- - - **DUAL** (*shows %SPO2+BPM*)
- - - **SPO2**
- - - **PULSE**
- - **ZOOM** (*cycle through 2h, 1h, 30m, and 15m for current view*)
- - **PRINT**
- - **BACK** (*to Trend menu*)
- **EXIT** (*to Main menu*)
- **SETUP** (Setup Monitor Menu)
- **VIEW** (Setup View Menu)
- - **PLETH**
- - **BLIP**
- - **TREND**
- - - **VIEW** (RT Trend View Menu)
- - - - **DUAL**
- - - - **SPO2**
- - - - **PULSE**
- - - - **BACK**
- - - **ZOOM** (RT Trend View Menu)
- - - - **TIME**
- - - - **SCALE**
- - - - **AUTO**
- - - - **BACK**
- - **BACK** (*back to Setup menu*)
- **SENSOR** (Setup Sensor Menu)
- - **DATA** (*On-screen options for SENSOR-R (Write-once Sensor) sensor are: "SPO2, SPO2+BPM, DEFAULT." On-screen options for SENSOR-RW (rewritable sensor) are: "SPO2, SPO2+BPM, DEFAULT." SELECT toggles SENSOR-R or SENSOR-RW sensor type; up/down keys scroll through options in order.)
The SENSOR-R feature supports all of the current OxiMAX sensors.*)
- - - **SELECT**
- - - **BACK** (*back to Setup Sensor menu*)
- - - **EXIT** (*to Main menu*)
- - **MSG** (Sensor Set Message Menu)
- - - **BACK** (*back to Setup Sensor menu*)
- - - **EXIT** (*to Main menu*)
- **NEXT** (Clock/Language Menu)
- - **CLOCK** (Clock Menu)
- - - **SET** (Clock Set Menu)

- - - - **SELECT** (press select to toggle through hours, minutes, seconds, month, day, year; use up/down buttons to set each selection)
- - - - **BACK** (back to Clock/Language menu)
- - - - **EXIT** (to Main menu)
- - - **BACK** (back to Clock/Language menu)
- - - **EXIT** (to Main menu)
- - **LANG** (Language Setup Menu) (use up/down buttons to toggle through languages)
- - - **BACK** (back to Clock/Language menu)
- - **NEXT** (Communication/Nurse Call Menu)
- - - **COMM** (Communication Port Configuration Menu)
- - - - **SELECT**
- - - - **BACK** (back to Communication/Language menu)
- - - - **EXIT** (to Main menu)
- - - **NCALL** (Nurse Call Menu)
- - - - **NORM +**
- - - - **NORM -**
- - - - **BACK** (back to Communication/Nurse Call menu)
- - - - **EXIT** (to Main menu)
- - - **NEXT** (Analog/Mode Menu)
- - - - **ANALOG** (Analog Voltage Select Menu)
- - - - - **0 VOLT**
- - - - - **1 VOLT**
- - - - - **STEP**
- - - - - **BACK** (back to Analog/Mode menu)
- - - - **MODE** (Mode Menu)
- - - - - **BACK** (back to Analog/Mode menu)
- - - - - **EXIT** (to Main menu)
- - - - **BACK** (back to Communication/Nurse Call menu)
- - - - **EXIT** (to Main menu)
- - - **BACK** (back to Clock/Language menu)
- - **BACK** (back to Setup menu)
- **EXIT** (to Main menu)
- LIGHT** (Light Menu)
- **OFF** (turns display backlight off)
- **EXIT** (to Main menu)

Related Documents

An understanding of the *OxIMAX N-600x* monitor is critical in order to perform the tests, troubleshoot procedures, use the principles of operation, and circuit analysis sections of this manual. Refer to the *OxIMAX N-600x Operator's Manual*. To utilize the various Nellcor approved *OxIMAX* sensors used with the monitor, refer to the individual *OxIMAX* Sensor's *Directions for Use (DFU)*.

The *OxIMAX N-600x Operator's* and *Service Manuals* are posted on the Internet at:

<http://www.nellcor.com>

A Spare Parts and Accessories list is also posted on the Internet at:

<http://www.nellcor.com>

Routine Maintenance

Cleaning the Monitor



WARNING: Do not spray, pour, or spill any liquid on the *N-600x*, its accessories, connectors, switches, or openings in the chassis as this may damage the pulse oximeter.

For *surface-cleaning* and *disinfecting* follow your institution's procedures or use the steps outlined below:

To surface clean the monitor:

1. Obtain a soft cloth.
2. Dampen the cloth with either a commercial, non-abrasive cleaner or a solution of 70% alcohol in water.
3. Lightly wipe each exterior surface using the dampened soft cloth.

To disinfect the monitor:

1. Saturate a soft cloth with 10% solution of chlorine bleach in tap water.
2. Lightly wipe each exterior surface using the saturated soft cloth.



Caution: Before attempting to clean an SpO₂ *OXIMAX* sensor, read the directions for use enclosed with the *OXIMAX* sensor. Each sensor model has specific cleaning instructions.

Periodic Safety Checks

The *N-600x* monitor requires no calibration. The battery should be replaced at least every two years. See *Battery Replacement* on page 88.

The following safety checks should be performed at least every 24 months by a qualified service technician.

To perform a periodic safety check:

1. Inspect the equipment for mechanical and functional damage.
2. Inspect safety labels for legibility.
3. Contact Nellcor's Technical Services Department, 1.800.635.5267, or your local Nellcor representative if the labels are damaged.

Functional Checks

If the monitor has been visibly damaged or subjected to mechanical shock (for example, if dropped), immediately perform the performance tests. See *Performance Tests* on page 16.

The following checks should be performed at least every two years by a qualified service technician.

To perform a functional check:

1. Perform the electrical safety tests detailed in *Safety Tests* on page 46. If the unit fails the tests, refer to *Spare Parts* on page 103.
2. Inspect the fuses for proper value and rating ($F1 + F2 = 0.5$ amp, 250 volts).

Battery Operation

The *N-600x* has an internal battery that can be used to power the monitor during transport or when AC power is not available. A new, fully-charged battery provides at least seven hours of monitoring time under the following conditions:

- No audible alarms sound
- No analog or serial output devices are attached to the *N-600x*
- Default display brightness setting

The monitor cannot be used when the battery is depleted unless the monitor is connected to an AC power source. A warning message displays and must be cleared by pressing the ALARM SILENCE button twice before the monitor can be used for patient monitoring.

The pleth and blip displays include the Battery Fuel Gauge indicator that shows the remaining charge (operating hours). When the monitor is fully-charged, all four *N-600x* bars are lit on the indicator.



Note: After three months of storage, the battery may lose its charge. The *N-600x* will not power up until the AC power is established. On AC power up, the battery fuel gauge shows empty. The *N-600x* operates on AC power while the battery is charging. Until the battery is recharged, the message, “UNIT WILL SHUT DOWN IF AC POWER IS LOST” appears. The monitor is now operational. Press the ALARM SILENCE button twice to remove the message from the screen.



Caution: If the battery has been in storage for longer than six months, or if the battery does not fully recharge, the battery should be replaced. After the battery has been replaced and a new battery had been charged, an “EEE 575 Trends Lost” message appears when the *N-600x* is turned on. Turn the *N-600x* off and wait three seconds. Then turn the monitor on again. After the extended power-on self-test, the *N-600x* runs on AC or battery power.



Caution: To fully recharge the monitor, it may take up to eight hours if the monitor is turned off or 12 hours if the monitor is turned on. Connect the monitor to an AC power outlet to charge a low or fully-depleted battery.



Caution: The battery terminal clips may loosen after repeated insertions. After replacing the battery, check the battery terminal clips for secure fit and tighten if necessary (needle nose pliers may be used).



WARNING: If the monitor is operating on an AC power source with a fully-depleted battery and the AC power is subsequently lost, the monitor will shut down immediately.

When all of the following conditions are present for 15 minutes, the N-600x automatically shuts down:

- Monitor is running on battery power
- No buttons have been pressed
- No pulse has been detected (for example, when a patient is not connected to the *OxIMAX* sensor or the *OxIMAX* sensor is disconnected from the monitor)
- No alarms are present (other than low battery or a non-correctable error)



Note: Whenever the monitor is connected to an AC power source, the battery is being charged. We recommend the monitor remain connected to an AC power source when not in use. This ensures full battery power when the monitor is needed.



Caution: Repeated deep discharge reduces the life of the battery.

Performance Verification

Overview

This section discusses the tests used to verify performance following repairs or during routine maintenance. All tests can be performed without removing the *N-600x* cover. All tests except the battery charge and battery performance tests must be performed as the last operation before the *N-600x* is returned to the Caregiver.

If the *N-600x* fails to perform as specified in any test, repairs must be made to correct the problem before the monitor is returned.

Required Equipment

Table 1: Equipment and Descriptions

Equipment	Description
Digital Multimeter (DMM)	Fluke Model 87 or equivalent
<i>Durasensor</i> [®] <i>OXIMAX</i> Oxygen Sensor	DS-100A sensor
<i>OXIMAX</i> Oxygen Sensor	MAX-A sensor
Safety Analyzer	Must meet current AAMI ESI/1993 & IEC 60601-1/1998 specifications
Pulse Oximetry Cable	DOC-10 cable
Data Interface Cable	EIA-232 cable (optional)
Stop Watch	Manual or electronic
Nellcor model SRC-MAX Tester	Provides testing for DigiCal compatible Monitors

Performance Tests

The battery charge procedure should be performed before monitor repairs when possible.



Note: This section uses Nellcor factory defaults. If your institution has custom defaults, those values are displayed. Factory defaults can be restored (see *Reset Sofkey* on page 53).

Battery Charge

To fully charge the battery:

1. Connect the monitor to an AC power source.
2. Verify the monitor is off and the AC Power/Battery Charging indicator is lit.

3. Charge the battery for at least eight hours with the monitor turned off or twelve hours with the monitor turned on.

Power-Up Performance

The power-up performance tests verify the following monitor functions:

- *Power-On Self-Test (POST)* on page 16
- *Power-On Defaults and Alarm Range Limits* on page 19

Power-On Self-Test (POST)

To perform the power-on self-test:

1. Connect the monitor to an AC power source.
2. Verify the monitor is off and the AC Power indicator is lit.

3. Do not connect any cables to the monitor.

4. Turn on the *N-600x* by pressing the ON/STANDBY button. Observe the monitor front panel. The monitor must perform the following:
 - Within ten seconds, all LEDs, pixels and the backlight are illuminated.
 - The indicators remain lit for two seconds.
 - The LCD display shows NELLCOR and the software version of the *N-600x*.



Note: The software version displayed in the example below is x.x.x.x.



- A three beep power on tone sounds, followed by a one-second beep, indicating proper operation of the speaker and successful completion of the power on self tests. All indicators turn off except the AC Power/ Battery Charging indicator and the LCD screen.
- The monitor begins normal operation.



WARNING: If the *N-600x* monitor does not sound any audible tones during the power-on self-test (POST), please contact Nellcor's Technical Services or your local Nellcor representative.

PLETH Display

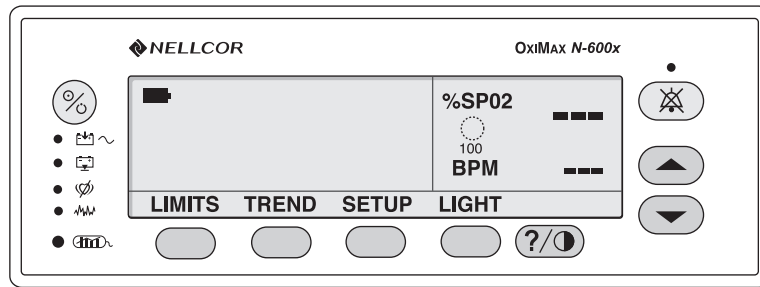

BLIP Display

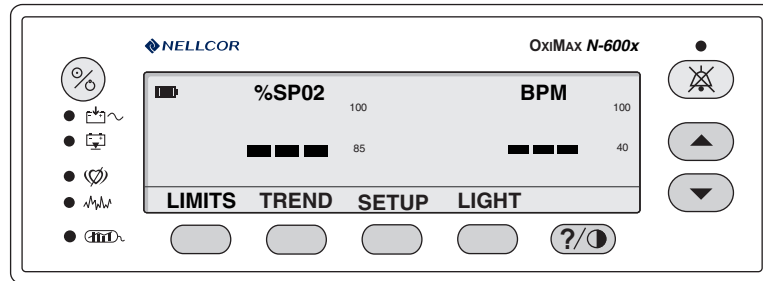

REAL-TIME TREND Display

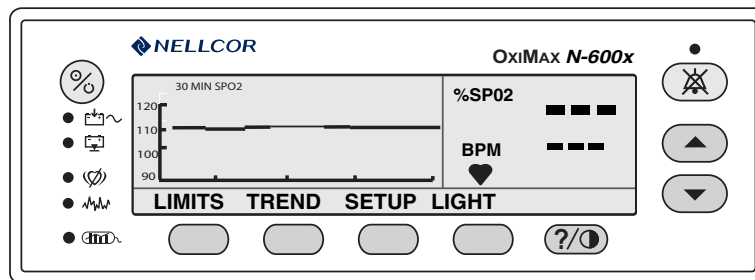

Power-On Defaults and Alarm Range Limits

 **Note:** When observing or changing alarm limits, a time-out is in effect (approximately ten seconds). If no action is taken within the time-out, the monitor automatically returns to the monitoring display.

 **Note:** The descriptions below are based on the assumption that the Pleth view is selected.

The steps for changing an alarm limit are the same if the view being used is the Blip (Magnified) view.

 **Note:** Power-on defaults are the factory-set or the defaults set by your institution.

To test the power-on and alarm range settings:

1. Turn on the monitor by pressing the ON/STANDBY button.
2. Press the LIMITS softkey.
3. Verify the monitor emits a single beep and the Pleth view is replaced with a display of the alarm limits. The selected Upper Alarm Limit for %SpO₂ indicates an alarm limit of “100” (or the applicable institutional default setting).

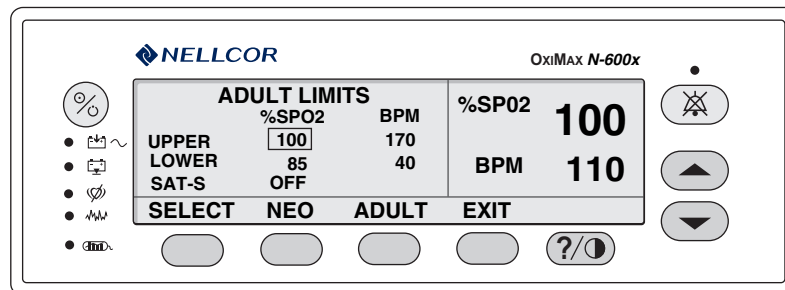

4. Press and hold the ADJUST DOWN button. Verify the selected number for %SpO₂ Upper Alarm Limit decreases to a minimum of “86.”

 **Note:** A decimal point in the display indicates the alarm limits have been changed from the factory default values.

5. Press the SELECT softkey. Verify the monitor emits a single beep and the %SpO₂ Lower Alarm Limit of “85” (or your institutional default setting) is selected.

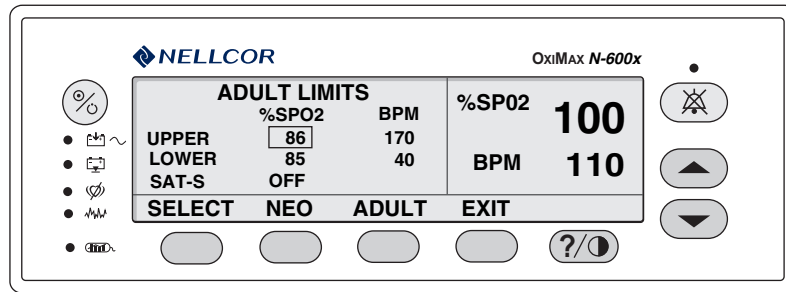

6. Press and hold the ADJUST DOWN button. Verify the %SpO₂ Lower Alarm Limit display reduces to a minimum of “20.”
7. Press and hold the ADJUST UP button. Verify the %SpO₂ Lower Alarm Limit display cannot be raised past the Upper Alarm Limit setting of “85.”
8. Press the LIMITS softkey.
9. Press the SELECT softkey three consecutive times. Verify the monitor emits a beep after each keystroke. The selected Pulse Upper Alarm Limit should be “170.”

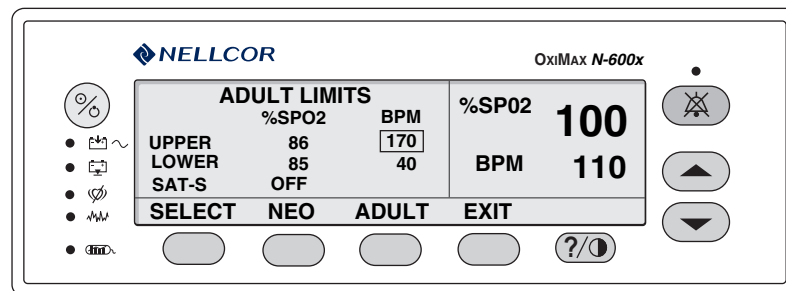

10. Press and hold the ADJUST DOWN button. Verify the minimum displayed value is “41” for the BPM Upper Alarm Limit.
11. Press the LIMITS softkey.

12. Press the SELECT softkey four consecutive times. Verify the selected Pulse Rate Lower Alarm Limit display indicates an alarm limit of “40.”

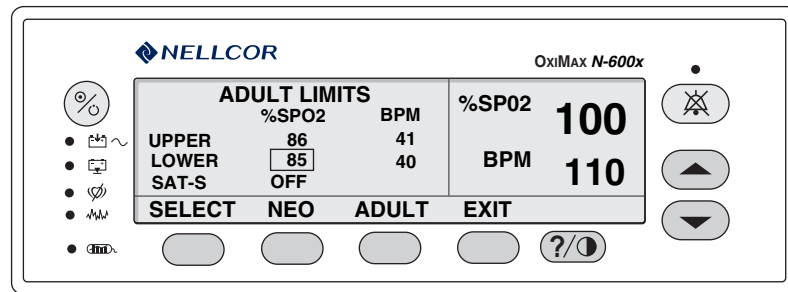

13. Press and hold the ADJUST DOWN button. Verify the selected Pulse Rate Lower Alarm Limit display decreases to a minimum of “30.”
14. Press and hold the ADJUST UP button. Verify the selected Pulse Rate Lower Alarm Limit display cannot be adjusted above the Pulse Rate Upper Alarm Limit of “40.”
15. Press the LIMITS softkey.
16. Press the SELECT softkey twice. Verify the *SatSeconds* SAT-S alarm is selected.

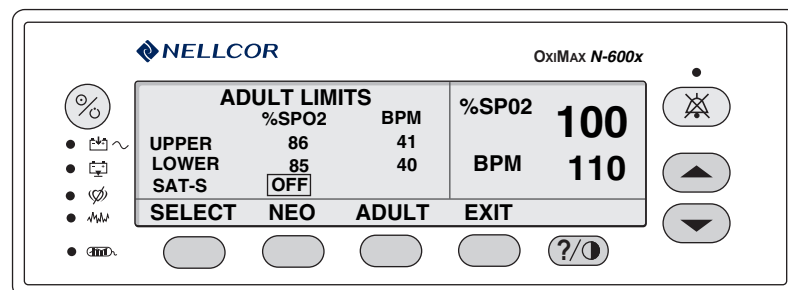

17. Press the ADJUST UP button repeatedly until the *SatSeconds* alarm display cycles from OFF through 10, 25, 50, 100, and OFF.
18. Press the ON/STANDBY button to turn the monitor off.
19. Press the ON/STANDBY button to turn the monitor back on.
20. Press the LIMITS softkey. Verify the selected %SpO2 Upper Alarm Limit display indicates an alarm limit of “100.”

21. Ensure the selected %SpO₂ Lower Alarm Limit display indicates an alarm limit of “85.”
22. Confirm the *SatSeconds* SAT-S alarm is OFF.
23. Ensure the Pulse Rate Upper Alarm Limit display is selected and indicates an alarm limit of “170.”
24. Ensure the Pulse Rate Lower Alarm Limit display is selected and indicates an alarm limit of “40.”
25. Press the ON/STANDBY button to turn the monitor off.

Operational Setup

The Operational Setup procedures confirm and configure the following parameters:

- *Alarms and Alarm Silence* on page 23
- *Alarm Volume Control* on page 25
- *Pulse Tone Volume Control* on page 26
- *Nurse Call* on page 26
- *Using the Analog Output* on page 27
- *Using Battery Power* on page 29

Alarms and Alarm Silence



WARNING: Pressing ALARM SILENCE will keep ALL alarms from sounding for the alarm silence duration period.

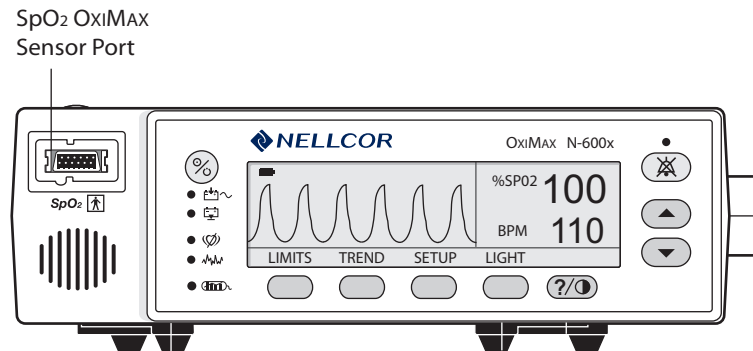

To adjust the alarms and alarm silence options:

1. Connect the DOC-10 pulse oximetry cable to the monitor's SpO2 *OxIMAX* sensor port.
2. Connect the DS-100A *OxIMAX* sensor to the DOC-10 cable and your finger.
3. Press the ON/STANDBY button to turn the monitor on.
4. Press SETUP and then VIEW.
5. Press the Pleth softkey. Verify the %SpO2 and BPM indicate the %SpO2 and pulse rate.
6. Press the LIMITS softkey.
7. Press the SELECT softkey to select %SpO2 Lower Alarm Limit.
8. Press the ADJUST UP button until the %SpO2 Lower Alarm Limit indicates 99.
9. Press the SELECT softkey three consecutive times to select Pulse Rate Lower Alarm Limit.

10. Press the ADJUST UP button until the Pulse Rate Lower Alarm Limit indicates 160.

11. Confirm the following monitor results:
 - The Plethysmograph waveform tracks the pulse rate.
 - The Pulse Tone is audible.
 - The %SpO₂ and pulse rate are flashing in the %SpO₂ and BPM displays.
 - The Audible Alarm sounds, indicating both parameters have violated the alarm limits.

12. Press and hold the ALARM SILENCE button until the BPM display indicates “SEC.”

13. Continue to press the ALARM SILENCE button. Press the ADJUST DOWN button until “60” appears in the %SpO₂ display.

14. Press the ALARM SILENCE button.

15. With the monitor’s alarm silenced, verify the:
 - alarm remains silenced for 60 seconds
 - Alarm Silence indicator lights
 - %SpO₂ and BPM displays continue to flash
 - pulse tone is audible
 - audible alarm returns in approximately 60 seconds

16. Press and hold the ALARM SILENCE button until the BPM display indicates “SEC.” Continue to press the ALARM SILENCE button and press the ADJUST DOWN button until “30” appears in the %SpO₂ display.

17. Press the ADJUST UP button. Verify the displays indicate 60 SEC, 90 SEC, 120 SEC, and OFF. Release the ADJUST UP button once the display indicates “OFF.” “OFF” will only be displayed if the “ALLOW OFF” option was enabled in the Service menu.

18. Press and release the ALARM SILENCE button. Verify the monitor's Alarm Silence indicator flashes.
19. Wait approximately three minutes.
20. Verify the monitor's alarm does not return. After three minutes, the monitor's alarm silence reminder sounds three times, at approximately three minute intervals.

Alarm Volume Control



WARNING: Pressing ALARM SILENCE will keep ALL alarms from sounding for the alarm silence duration period.

After adjusting the alarm volume, perform the following alarm volume test procedure.

To test the alarm volume:

1. Press and hold the ALARM SILENCE button and verify the following:
 - “OFF” is displayed for approximately three seconds.
 - After three seconds, a steady tone is audible at the default alarm volume setting, the %SpO₂ display indicates “VOL,” and the BPM display indicates the default setting of 7.
2. While pressing the ALARM SILENCE button, press the ADJUST DOWN button until an alarm volume setting displays 1.
3. Verify the volume of the alarm has decreased.
4. Continue pressing the ALARM SILENCE button. Press the ADJUST UP button to increase the alarm volume setting to a maximum value of 10. Verify the volume increases.
5. Continue pressing the ALARM SILENCE button while pressing the ADJUST DOWN button to a comfortable audio level.
6. Release the ALARM SILENCE button. The tone discontinues.

Pulse Tone Volume Control

Adjust the pulse tone volume after completing the *Alarm Volume Control* on page 25.

To set the pulse tone volume:

1. Press the ADJUST UP button and verify the sound level of the beeping pulse tone volume increases.
2. Press the ADJUST DOWN button and verify the sound level of the beeping pulse tone is silent.
3. Press the ADJUST UP button to return the beep volume to a comfortable audible level.
4. Remove the *OxiMAX* sensor from the finger and disconnect the DOC-10 cable from the monitor.

Nurse Call

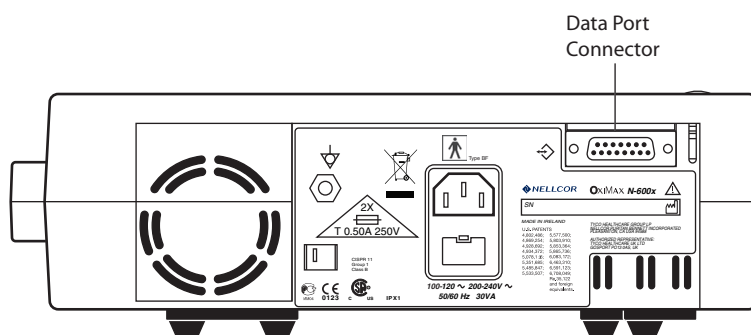

To set the nurse call setting:

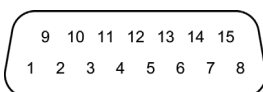

1. Connect the negative lead of a voltmeter to pin 5 and positive lead to pin 11 of the Data Port Connector on the back of the monitor.
2. Ensure the audible alarm is not turned off.
3. Connect the SRC-MAX tester to the DOC-10 pulse oximetry cable.
4. Connect the DOC-10 cable to the monitor SpO₂ *OxiMAX* sensor port.

- Turn on the monitor and wait for the POST process to complete.



Note: The monitor should indicate a %SpO₂ alarm of 75.

- Verify an output voltage at pins 5 and 11 between +5 to +12 VDC.
- Press the ALARM SILENCE button. With the audible alarm silenced, the output voltage at pins 5 and 11 must be between -5 to -12 VDC, verifying the RS-232 Nurse Call function.
- While the instrument in an alarm condition, use a digital voltmeter (DVM) to ensure there is no continuity (1 megohms or greater) between pins 8 and 15 and there is continuity (60 ohms or less) between pins 7 and 15.



- Press the SRC-MAX tester %SpO₂ button to change the %SpO₂ to 90.
- Use a DVM to verify there is continuity between pins 8 and 15 and that there is no continuity between pins 7 and 15, verifying the solid state Nurse Call function.

Using the Analog Output

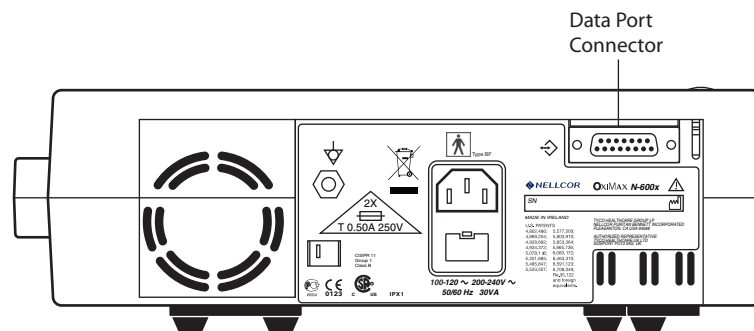

To set the analog output settings:

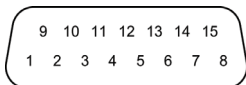

- Connect the negative lead of a voltmeter to pin 10 and the positive to lead pin 6 of the Data Port Connector on the back of the monitor.
- Press the SETUP softkey.
- Press the NEXT softkey three consecutive times.

4. Press ANALOG and then the 1 VOLT softkey.
5. Confirm the monitor's output voltage is $+1.0 \pm 0.025$ VDC, verifying the analog SpO₂ function.
6. Leave the negative lead connected to pin 10 and verify 1.0 ± 0.025 VDC on pins 13 and 14, verifying the monitor's BPM and Pleth functions.



Note: If step 6 takes more than two minutes to complete, the analog output times out. Repeat steps 2 through 6 to initiate the analog output.

7. Move the positive lead back to pin 6.
8. Press the SETUP softkey.
9. Press the NEXT softkey three consecutive times.
10. Press ANALOG and then the 0 VOLT softkey.
11. Verify the monitor's output voltage is $+0.0 \pm 0.025$ VDC.
12. Leave the negative lead connected to pin 10 and verify 0.0 ± 0.025 VDC on pins 13 and 14.



Note: If step 12 takes more than two minutes to complete, the analog output times out. Repeat steps 7 through 12 to initiate the analog output.

13. Disconnect the voltmeter from the monitor.

Using Battery Power

To operate the battery power:

1. Disconnect the monitor from AC power and verify the AC Power indicator shuts off.
2. Verify the monitor is operating normally and the Low Battery indicator is off.



Note: If the Low Battery indicator is lit, see *Battery Charge* on page 16.

3. Connect the monitor to an AC power source and verify the AC Power indicator turns on and the monitor is operating normally.

General Operation

The following tests are an overall performance check of the system:

- *LED Excitation Test* on page 29.
- *Operation with a Live Subject* on page 31.

LED Excitation Test

The LED Excitation Test utilizes normal system components to test circuit operation. A Nellcor *OxiMAX* oxygen sensor, model MAX-A, is used to examine LED intensity control. The red LED is used to verify intensity modulation caused by the LED intensity control circuit.

SpO₂ OxiMAX
sensor port

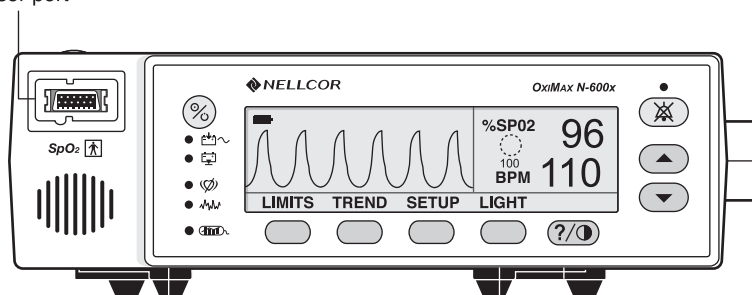

To test the circuit operation:

1. Connect the monitor to an AC power source.
2. Connect a DOC-10 pulse oximetry cable to the monitor SpO₂ *OxiMAX* sensor port.
3. Connect a MAX-A *OxiMAX* sensor to the *OxiMAX* sensor-input cable.
4. Press the ON/STANDBY button to turn the monitor on.
5. Leave the *OxiMAX* sensor open with the LEDs and photo detector visible.
6. After the monitor completes its normal power-up sequence, verify the *OxiMAX* sensor LED is brightly lit.
7. Slowly move the *OxiMAX* sensor LED in proximity to the photo detector element of the *OxiMAX* sensor (close the *OxiMAX* sensor slowly).
8. Verify the LED intensity decreases as the LED approaches the optical *OxiMAX* sensor.
9. Open the *OxiMAX* sensor and notice the LED intensity increases.
10. Repeat step 8 and the intensity continues to decrease. This variation is an indication the microprocessor is in proper control of LED intensity.
11. Press the ON/STANDBY button to turn off the monitor.

Operation with a Live Subject

Patient monitoring involves connecting the *OxiMAX* sensor to a live subject for a qualitative test.

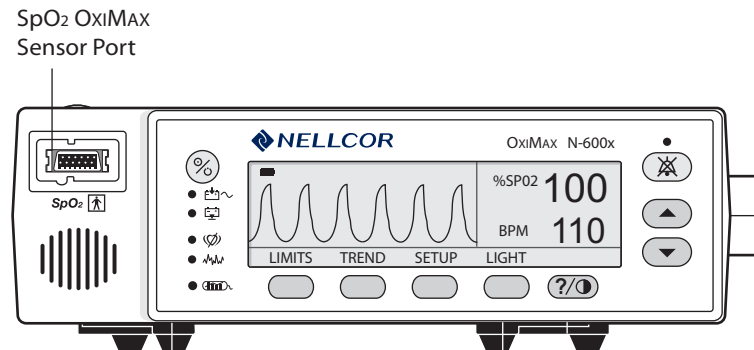

To test using a live subject:

1. Ensure the monitor is connected to an AC power source.
2. Connect a DOC-10 pulse oximetry cable to the monitor SpO₂ *OxiMAX* sensor port.
3. Connect a Nellcor *OxiMAX* MAX-A oxygen *OxiMAX* sensor to the pulse oximetry cable.
4. Clip the MAX-A to the subject as recommended in the *OxiMAX* sensor's *Directions For Use*.
5. Press the ON/STANDBY button to turn the monitor on and verify the monitor is operating.
6. The monitor should stabilize on the subject's physiological signal in about 15 to 30 seconds. Verify the oxygen saturation and pulse rate values are reasonable for the subject.

Pulse Oximetry Functional Tests

These tests utilize the pulse oximetry functional tester (Nellcor model SRC-MAX) to verify the performance of the monitor. See Figure 3.

All of the following tests should be completed in sequence.

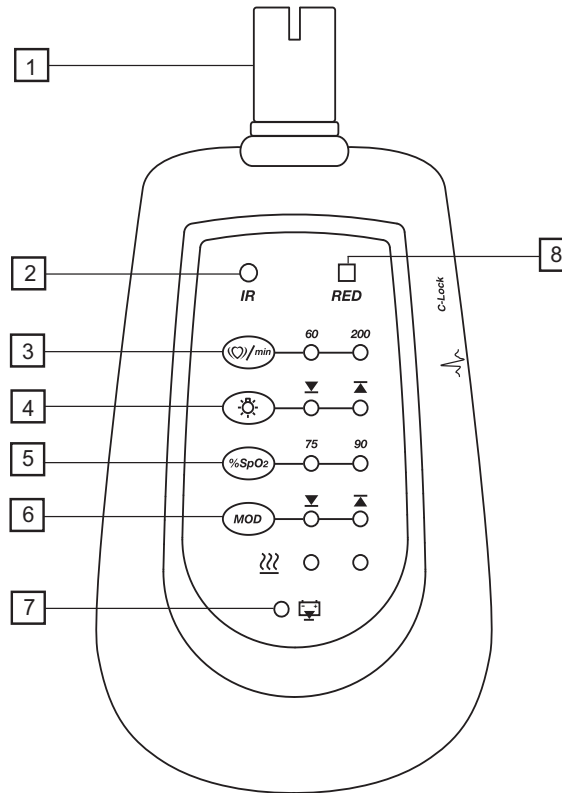

1. DOC-10 Cable Connector	5. % SpO ₂ Select Button
2. Infrared LED Drive Indicator	6. % Modulation Select Button
3. Pulse Rate Selection Button	7. Battery Low Indicator
4. Light Level Selection Button	8. Red LED Drive Indicator

Figure 3: SRC-MAX OxIMAX Oximetry Tester

Overview

The SRC-MAX functional tester enables qualified technicians to functionally test Nellcor *OxIMAX* technology-based pulse oximeters and OEM *OxIMAX* technology-based monitors. The following table provides a brief description of each test.

Table 2:

Tests	Descriptions
Test No. 1: BPM	The test procedure simulates an <i>OxIMAX</i> sensor attached to a patient indicating 60 BPM and 200 BPM.
Test No. 2: SpO₂	The test procedure simulates an <i>OxIMAX</i> sensor attached to a patient indicating 75% blood oxygen saturation and 90% blood oxygen saturation.
Test No. 3: Modulation Level	The test procedure simulates an <i>OxIMAX</i> sensor attached to a patient indicating low and high pulse strength.
Test No. 4: Light	The test procedure simulates an <i>OxIMAX</i> sensor attached to a patient indicating low and high light level passing through the patient at the sensor site.



Note: The SRC-MAX selectable indicator LEDs may extinguish if there is a delay in proceeding through the above tests. This is normal operation in order to increase the battery time.



Note: Pressing a button during the test procedures may be requested, changing a certain parameter. If the LEDs are not lit, press the button twice. Pressing the button once causes the indicators to relight and pressing twice initiates the change.

Test No. 1: BPM



1. With the monitor turned off, connect the DOC-10 pulse oximetry cable to the sensor port.

2. Connect the SRC-MAX tester to the other end of the DOC-10 cable.

3. Turn on the monitor by pressing the ON/STANDBY button. After the monitor completes its self-check, the following screen displays:

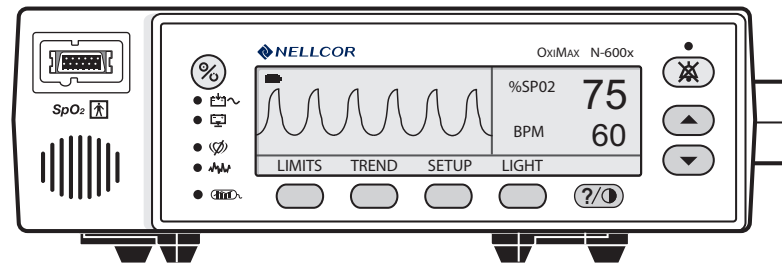

- Active audio alarm.
 - Flashing %SpO₂ indication between 73 and 77 inclusive.
 - BPM indication between 57 and 63 inclusive.
 - Pulse waveform of approximately 1/2-inch peak to peak (P-T-P) amplitude. Actual amplitude may vary but will be a reference for low pulse amplitude/low light patients.
4. Press the SRC-MAX PULSE RATE selection button. The SRC-MAX PULSE RATE 200 LED lights. The monitor BPM increases and stabilizes to a value between 197 to 203 BPM inclusive. The following screen displays:

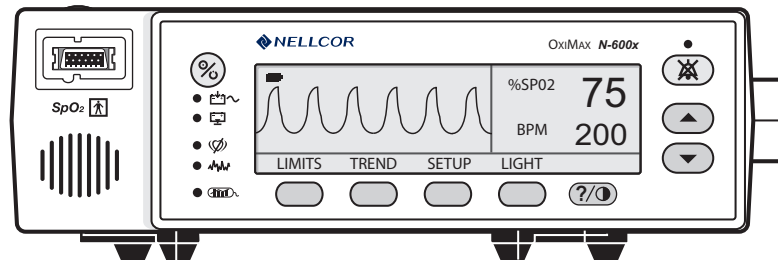

- Active audio alarm.
- Flashing %SpO₂ indication between 73 and 77 inclusive.
- Flashing BPM indication between 197 and 203.
- Pulse waveform of approximately 1/2-inch P-T-P amplitude. Actual amplitude may vary but references low pulse amplitude/low light patients.



5. Press the SRC-MAX PULSE RATE selection button. The SRC-MAX PULSE RATE 60 LED lights. The monitor BPM decreases and stabilizes to a value between 67 to 73 BPM inclusive. The following screen displays.

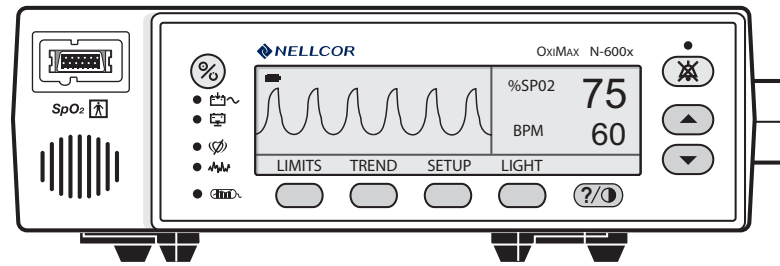

- Active audio alarm.
 - Flashing %SpO₂ indication between 73 and 77 inclusive.
 - BPM indication between 57 and 63 inclusive.
 - Pulse waveform of approximately 1/2-inch P-T-P amplitude. Actual amplitude may vary but will be a reference for low pulse amplitude/low light patients.
6. Turn off the monitor.

Test No. 2: SpO₂

1. With the monitor turned off, connect the DOC-10 pulse oximetry cable to the sensor port.
2. Connect the SRC-MAX tester to the other end of the DOC-10 cable.

- Turn on the monitor by pressing the ON/STANDBY button. After the monitor completes its self-check, the following screen displays:

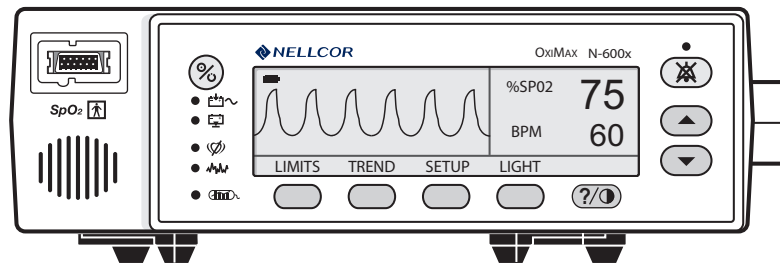

- Active audio alarm
- Flashing %SpO₂ indication between 73 and 77 inclusive
- BPM indication between 57 and 63 inclusive
- Pulse waveform of approximately 1/2-inch P-T-P amplitude. Actual amplitude may vary but will be a reference for low pulse amplitude/low light patients



- Press the SRC-MAX %SpO₂ selection button. The SRC-MAX %SpO₂ 90 LED lights.

The monitor displays three dashes [- - -] until the %SpO₂ stabilizes at a value between 88 and 92 inclusive. The following screen displays:

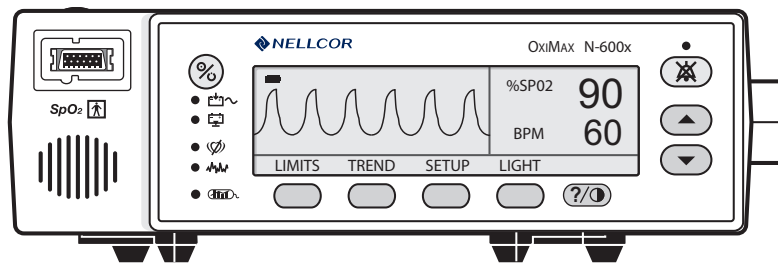

- No audio alarm.
- %SpO₂ indication between 88 and 92 inclusive.
- BPM indication between 57 and 63 inclusive.
- Pulse waveform of approximately 1/2-inch P-T-P amplitude. Actual amplitude may vary but will be a reference for low pulse amplitude/low light patients.

5. Press the SRC-MAX %SpO₂ selection button. The SRC-MAX %SpO₂ 75 LED lights. The monitor displays three dashes [- - -] until stabilizing at a value between 73 and 77 inclusive. The following screen displays:

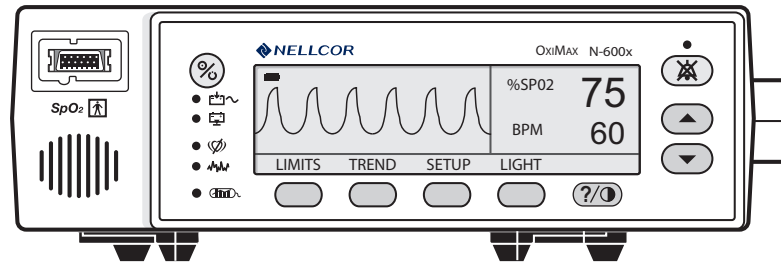

- Active audio alarm.
- Flashing %SpO₂ indication between 73 and 77 inclusive.
- BPM indication between 57 and 63 inclusive.
- Pulse waveform of approximately 1/2-inch P-T-P amplitude. Actual amplitude may vary but will be a reference for low pulse amplitude/low light patients.

Test No. 3: Modulation Level

1. With the monitor turned off, connect the DOC-10 pulse oximetry cable to the sensor port.
2. Connect the SRC-MAX tester to the other end of the DOC-10 cable.

- Turn on the monitor by pressing the ON/STANDBY button. After the monitor completes the self-check, the following screen displays:

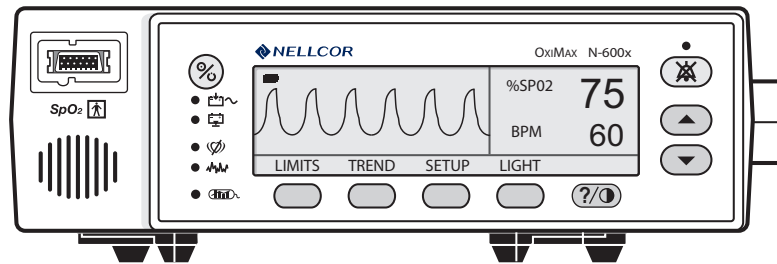

- Active audio alarm.
- Flashing %SpO₂ indication between 73 and 77 inclusive.
- BPM indication between 57 and 63 inclusive.
- Pulse waveform of approximately 1/2-inch P-T-P amplitude. Actual amplitude may vary but will be a reference for low pulse amplitude/low light patients.

MOD

- Press the SRC-MAX MODULATION selection button. The SRC-MAX Modulation  LED lights. The monitor pulse amplitude waveform initially increases in amplitude and then stabilize at P-T-P amplitude of approximately 1-inch. The following screen displays:

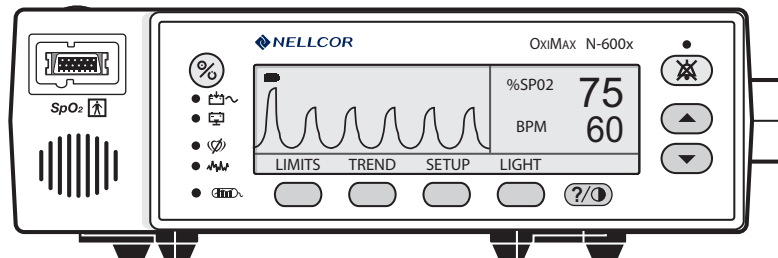

- Active audio alarm.
- Flashing %SpO₂ indication between 73 and 77 inclusive.
- BPM indication between 57 and 63 inclusive.
- Pulse waveform of approximately 1-inch P-T-P amplitude. Actual amplitude may vary but will be a reference for low pulse amplitude/low light patients.

5. Press the SRC-MAX PULSE RATE selection button. The SRC-MAX PULSE RATE 200 LED lights. The monitor BPM increases and stabilizes to a value between 197 and 203 inclusive. The following screen displays:

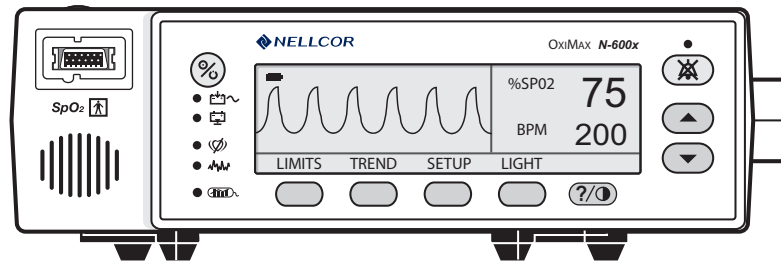

- Active audio alarm.
 - Flashing %SpO₂ indication between 73 and 77 inclusive.
 - Flashing BPM indication between 197 and 203 inclusive.
 - Pulse waveform of approximately 1-inch P-T-P amplitude. Actual amplitude may vary but will be a reference for low pulse amplitude/low light patients.
6. Press the SRC-MAX PULSE RATE selection button. The SRC-MAX PULSE RATE 60 ▼ LED lights. The monitor pulse rate decreases and stabilizes at a value between 57 and 63 inclusive. The following screen displays:

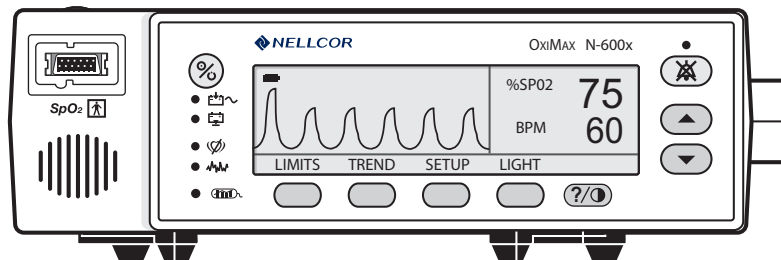

- Active audio alarm.
- Flashing %SpO₂ indication between 73 and 77 inclusive.
- BPM indication between 57 and 63 inclusive.
- Pulse waveform of approximately 1-inch P-T-P amplitude. Actual amplitude may vary, but can be used as a reference for low pulse amplitude/low light patients.

7. Press the SRC-MAX %SpO₂ selection button. The SRC-MAX %SpO₂ 90 LED lights. The monitor displays three [- - -] dashes until the %SpO₂ stabilizes to a value between 88 and 92 inclusive. The following screen displays:

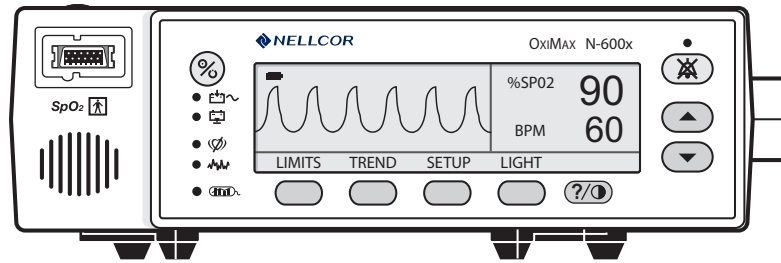

- No active audio alarm.
 - %SpO₂ indication between 88 and 92 inclusive.
 - BPM indication between 57 and 63 inclusive.
 - Pulse waveform of approximately 1-inch P-T-P amplitude. Actual amplitude may vary, but can be used as a reference for high pulse amplitude/low light patients.
8. Press the SRC-MAX %SpO₂ selection button. The %SpO₂ 75 LED lights.

The monitor displays three dashes [- - -] and stabilizes at a value between 73 and 77 inclusive. The following screen displays:

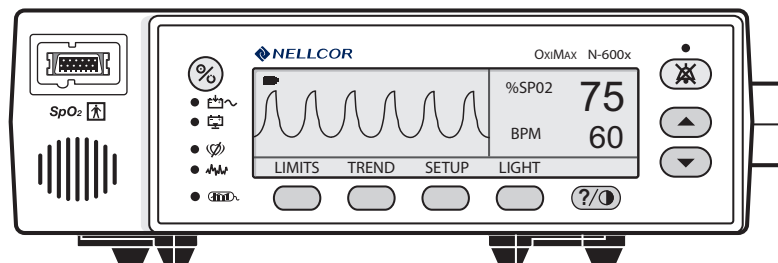

- Active audio alarm.
- Flashing %SpO₂ indication between 73 and 77 inclusive.
- BPM indication between 57 and 63 inclusive.
- Pulse waveform of approximately 1-inch P-T-P amplitude. Actual amplitude may vary, but can be used as a reference for low pulse amplitude/low light patients.

9. Press the SRC-MAX MODULATION selection button. The SRC-MAX MODULATION LED lights. The monitor pulse amplitude waveform decreases in amplitude. The following screen displays:

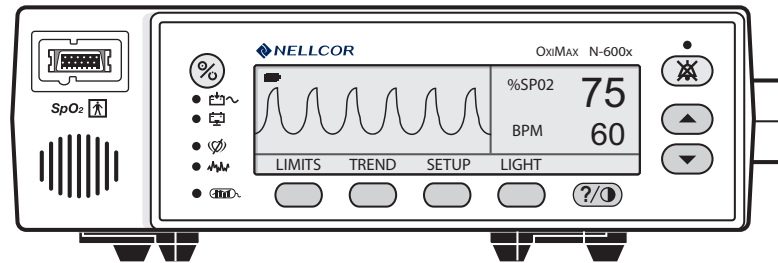

- Active audio alarm.
 - Flashing %SpO₂ indication between 73 and 77 inclusive.
 - BPM indication between 57 and 63 inclusive.
 - Pulse waveform of approximately 1/2-inch P-T-P amplitude. Actual amplitude may vary, but can be used as a reference for low pulse amplitude/low light patients.
10. Turn off the monitor.

Test No. 4: Light

1. With the monitor turned off, connect the DOC-10 pulse oximetry cable to the sensor port.
2. Connect the SRC-MAX tester to the other end of the DOC-10 cable.

- Turn on the monitor by pressing the ON/STANDBY button. After the monitor completes a self-check, the following screen displays:

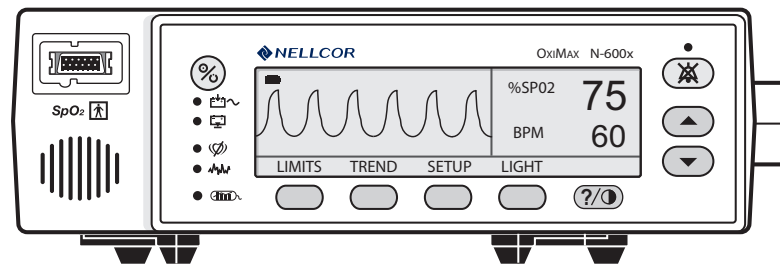

- Active audio alarm.
- Flashing %SpO₂ indication between 73 and 77 inclusive.
- BPM indication between 57 and 63 inclusive.
- Pulse waveform of approximately 1/2-inch P-T-P amplitude. Actual amplitude may vary, but can be used as a reference for low pulse amplitude/low light patients.



- Press the SRC-MAX LIGHT LEVEL selection button. The SRC-MAX LIGHT LEVEL LED lights. The monitor pulse amplitude waveform initially flatlines and stabilizes at the same amplitude.



Note: Flatlining is the only indication of a light change at the measurement site. If the monitor recovers and displays normally, this is an indication of proper operation with light changes. The following screen displays:

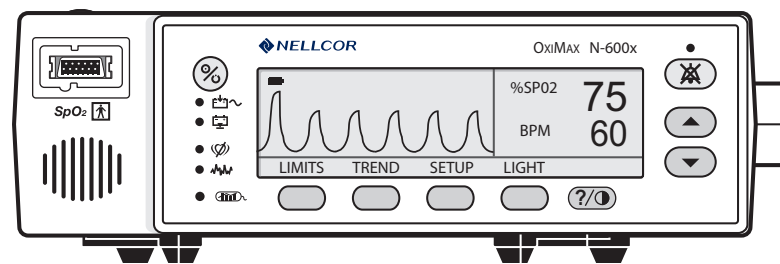

- Active audio alarm.
- Flashing %SpO₂ indication between 73 and 77 inclusive.
- BPM indication between 57 and 63 inclusive.
- Pulse waveform of approximately 1/2-inch P-T-P amplitude. Actual amplitude may vary, but can be used as a reference for low pulse amplitude/low light patients.

5. Press the SRC-MAX PULSE RATE selection button. The SRC-MAX PULSE RATE 200 LED lights. The monitor BPM increases and stabilizes at a value between 197 and 203 inclusive. The following screen displays:

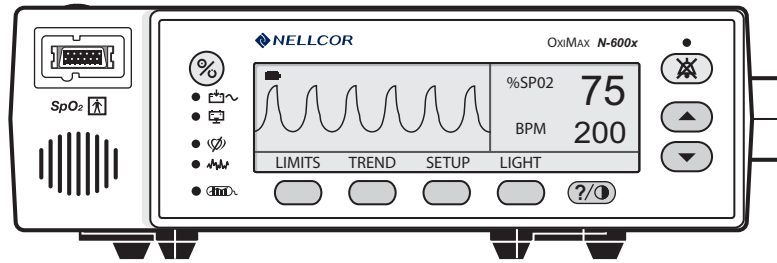

- Active audio alarm.
 - Flashing %SpO₂ indication between 73 and 77 inclusive.
 - Flashing BPM indication between 197 and 203 inclusive.
 - Pulse waveform of approximately 1/2-inch P-T-P amplitude. Actual amplitude may vary, but can be used as a reference for low modulation/low light indications.
6. Press the SRC-MAX PULSE RATE selection button. The SRC-MAX PULSE RATE 60 LED lights. The monitor pulse rate decreases and stabilizes at a value between 57 and 63 inclusive. The following screen displays:

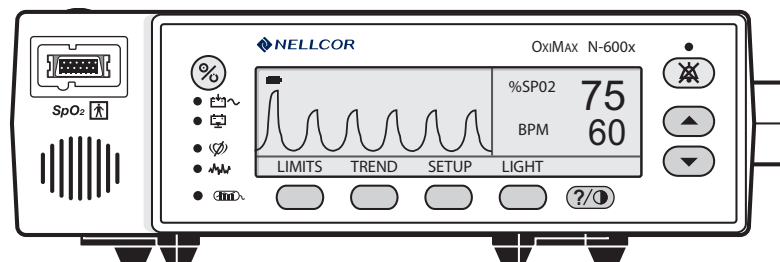

- Active audio alarm.
- Flashing %SpO₂ indication between 73 and 77 inclusive.
- BPM indication between 57 and 63 inclusive.
- Pulse waveform of approximately 1/2-inch P-T-P amplitude. Actual amplitude may vary, but can be used as a reference for low modulation/low light indications.

7. Press the SRC-MAX %SpO₂ selection button. The SRC-MAX %SpO₂ 90 LED lights. The monitor displays three dashes [- - -] and stabilizes at a value between 88 and 92 inclusive. The following screen displays:

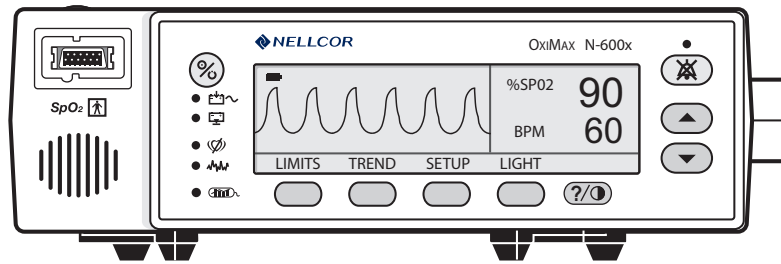

- No audio alarm.
 - %SpO₂ indication between 88 and 92 inclusive.
 - BPM indication between 57 and 63 inclusive.
 - Pulse waveform of approximately 1/2-inch P-T-P amplitude. Actual amplitude may vary, but can be used as a reference for low modulation/high light indications.
8. Press the SRC-MAX %SpO₂ selection button. The SRC-MAX %SpO₂ 75 LED lights.

The monitor displays three dashes [- - -] and stabilizes at a value between 73 and 77 inclusive. The following screen displays:

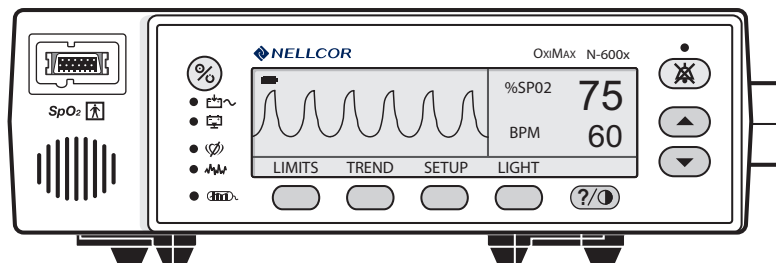

- Active audio alarm.
- Flashing %SpO₂ indication between 73 and 77 inclusive.
- BPM indication between 57 and 63 inclusive.
- Pulse waveform of approximately 1/2-inch P-T-P amplitude. Actual amplitude may vary, but can be used as a reference for low modulation/high light indications.

9. Press the SRC-MAX MODULATION selection button. The SRC-MAX MODULATION LED lights. The monitor pulse amplitude waveform increases in amplitude. The following screen displays:

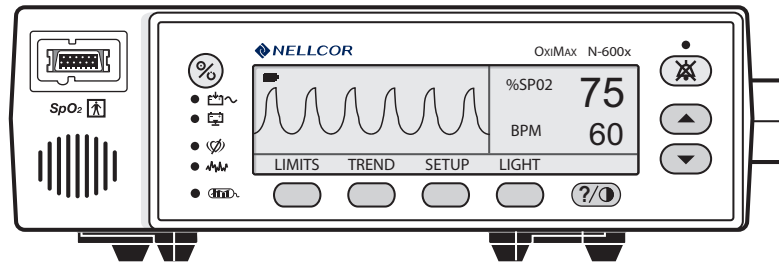

- Active audio alarm.
 - Flashing %SpO₂ indication between 73 and 77 inclusive.
 - BPM indication between 57 and 63 inclusive.
 - Pulse waveform of approximately 1-inch P-T-P amplitude. Actual amplitude may vary, but can be used as a reference for high modulation/high light indications.
10. Turn off the monitor.

Safety Tests

The N-600x safety tests meet the standards of, and are performed in accordance with the IEC 60601-1 (EN 60601-1, Amendment 1, Amendment 2,) and UL 2601-1, for instruments classified as Class 1 and TYPE BF and ANSI/AAMI Standard ES1.

Applicable tests for these standards are listed below. Technicians must be familiar with the standards applicable to their respective institution and country. Test equipment and its application must comply with the applicable standards:

- *Ground Integrity* on page 124 for test value.
- *Earth Leakage Current* on page 124 for test values.
- *Enclosure Leakage Current* on page 124 for test values.
- *Patient Applied Risk Current* on page 125 for test values.



Note: Patient Applied Risk Current and Patient Isolation Risk Current: The leakage test lead from the test equipment must be connected to the N-600x %SpO₂ Sensor Port through the DOC-10 pulse oximetry cable using a male 9-pin “D” type connector with all pins shorted together.

During these tests, the monitor displays the following message:
“RECONNECT/REPLACE SENSOR”.

Power-On Settings and Service Functions

Overview

This chapter discusses how to reconfigure power-on default values and access the service functions.

Adjusting the Power-On Settings

By using the softkeys as shown in Figure 1, you can change alarm limits, displays, baud rates, time and date, and trends to view.

Some values cannot be saved as power-on default values. An %SpO₂ Lower Alarm Limit less than 85 will not be saved as a power-on default. AUDIBLE ALARM OFF will not be accepted as a power-on default. An attempt to save either of these values as default results in an invalid tone. These limits can be adjusted lower for the current patient, but erased when the instrument is turned off.

A decimal point is added to the right of a display when the alarm limit for that display has been changed to a value that is not a power-on default value. If the new value is saved as a power-on default value, the decimal point is removed. By using the service functions, changes can be saved as power-on default values.

Factory Default Settings

Factory default settings are divided into two groups, adult and neonate. Default settings may be changed to institutional default settings; refer to *WARNING: Audible alarms should not be silenced if patient safety could be compromised.* on page 60.

Neonate Default Settings

Table 3: Neonate Alarm Limit Factory Defaults

Monitoring Mode	Setting
Note: Bold entries are different than adult default settings.	
%SpO₂ Lower Alarm Limit	85%
%SpO₂ Upper Alarm Limit	95%
Alarm Silence Duration	60 Seconds
Alarm Silence Duration OFF Setting	Disabled
Alarm Silence Reminder	Enabled
Alarm Volume	7 of 10
Backlight Brightness	8 (Battery Power) 10 (AC Power)
Data Port Baud Rate	9600
Data Port Protocol	ASCII
Display Contrast	Midrange
Display Format	Pleth
Language	English
Nurse Call Polarity	Normally Low
Pulse Beep Volume	4 of 10
Pulse Rate Lower Alarm Limit	90 BPM
Pulse Rate Upper Alarm Limit	190 BPM
Real-Time Trend Display	%SpO ₂
Real-Time Trend Scale	30 Minutes
Response Mode	Normal
<i>SatSeconds</i>	Off

Table 3: Neonate Alarm Limit Factory Defaults

Monitoring Mode	Setting
Note: Bold entries are different than adult default settings.	
<i>Allow SatSeconds</i>	Yes
Trend Display	%SpO ₂
Trend Scale	2 Hours

Adult Default Settings

Table 4: Adult Alarm Limit Factory Defaults

Monitoring Mode	Setting
Note: Bold entries are different than neonate default settings.	
%SpO₂ Lower Alarm Limit	85%
%SpO₂ Upper Alarm Limit	100%
Alarm Silence Duration	60 Seconds
Alarm Silence Duration Off Setting	Disabled
Alarm Silence Reminder	Enabled
Alarm Volume	7 of 10
Backlight Brightness	8 (Battery Power) 10 (AC Power)
Data Port Baud Rate	9600
Data Port Protocol	ASCII
Display Contrast	Midrange
Display Format	Pleth
Language	English
Nurse Call Polarity	Normally Low
Pulse Beep Volume	4 of 10
Pulse Rate Lower Alarm Limit	40 BPM
Pulse Rate Upper Alarm Limit	170 BPM
Real-Time Trend Display	%SpO ₂
Real-Time Trend Scale	30 Minutes
Response Mode	Normal
<i>SatSeconds</i>	Off
Allow <i>SatSeconds</i>	Yes
Sensor Adjust Enable	Yes/No
Trend Display	%SpO ₂
Trend Scale	2 Hours

Service Functions

Service functions can be used to select institutional defaults and to access information about the patient or instrument. Only a Nellcor Customer Service Technician should access many of the items available through the service functions.



Accessing the Service Functions

All service functions are accessible when the DOC-10 pulse oximetry cable is disconnected from the monitor. Disconnect the *OxiMAX* sensor from the DOC-10 pulse oximetry cable; or, disconnect the DOC-10 pulse oximetry cable from the instrument.

To access the service functions:

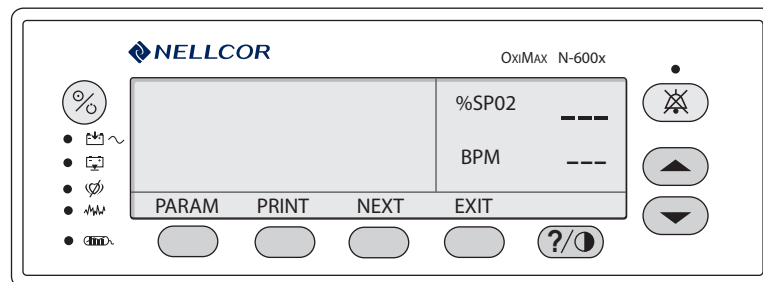
1. Turn on the monitor by pressing the ON/STANDBY button.
2. Wait for monitor power-on self-test to complete.
3. Simultaneously press and hold the LIGHT softkey and the HELP/CONTRAST button until the service softkeys display.



- 
Note: The service function is only accessible from the Main menu display. See *PARAM (Service Menu)* on page 52.
- 
Note: If the above step is performed with a pulse oximetry cable connected, only the PARAM and EXIT softkeys appear on the screen.

The following list can be used as a quick reference showing how to reach different softkey functions. Items reached through the PARAM softkey can be accessed during normal operation. Functions provided by the PRINT and NEXT softkeys cannot be accessed when a pulse oximetry cable is connected to the instrument. Each of the various functions is described below.

PARAM (Service Menu)

- **RESET**
- - **RESET DEFAULTS?**
- - - **YES** (*resets parameters to factory defaults, sounds three tones indicating defaults are reset*)
- - - **NO** (*back to Service menu*)
- **SAVE**
- - **SAVE DEFAULTS?**
- - - **YES** (*saves parameters as default settings, sounds three tones indicating defaults are saved*)
- - - **NO** (*back to Service menu*)
- **SENSOR** (*enables/disables patient alarm events to the sensor memory chip*)
- - **BACK** (*back to Service menu*)
- - **EXIT** (*back to Main menu, sounds three tones indicating defaults are reset*)
- **BACK** (*back to Service menu*)

PRINT

- **TREND**
- **ERRLOG**
- **INSTAT**
- **INFO**

NEXT

- **DOWNLD** (*for downloading monitor software*)
- **ALARMS**
- - **SELECT**
- - - **ALLOW OFF?** (Allows alarms to be turned off) (*up/down buttons select Yes/No*)
- - - **OFF REMINDER?** (enables/disables Alarm Off reminder) (*up/down buttons select Yes/No*)
- - - **ALLOW SAT-S?** (enables/disables Sat-Seconds reminder) (*up/down buttons select Yes/No*)
- - **BACK** (*back to Service menu*)
- **NEXT** (*back to Service menu*)
- - **BATTERY**
- - **NEXT**
- - **EXIT** (*back to Main menu*)
- **EXIT** (*back to Main menu*)

Exit Softkey

The EXIT softkey returns the monitor to the Main menu.

Next Softkey

The NEXT softkey enables you to view additional options available on various menu levels.

Param Softkey Menu

When the PARAM softkey is pressed, the function of the softkeys changes as shown below. These options can be accessed with the pulse oximetry cable connected to the instrument.

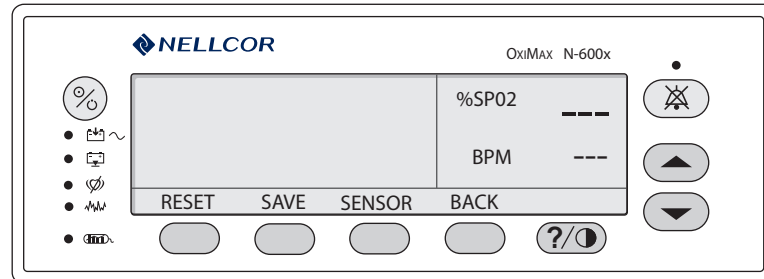

Reset Softkey

The RESET softkey can be used if any settings stored in memory have been changed from factory default values. Pressing YES sounds three tones and returns the settings to factory default values. Pressing NO stores the instrument settings into memory.

Save Softkey

When adjustable values are changed from factory default, the SAVE softkey can be used to preserve the settings as institutional power-on default values. Pressing YES stores the current settings in memory. The instrument sounds three tones indicating that the changes have been saved as power-on default values. The new saved values continue to be used through power-on and off cycles until they are changed and saved again, or until they are reset. Pressing NO restores the original default values.



Note: An invalid tone indicates a parameter value cannot be saved as a power-on default. See *Adjusting the Power-On Settings* on page 47. Along with the invalid tone, a message displays indicating which parameter could not be saved as a power-on default.

Sensor Softkey

The SENSOR softkey enables/disables the Sensor Event Record function.

Print Softkey Menu

Four printouts including TREND, ERRLOG, INSTAT, and INFO printouts become available when the PRINT softkey is pressed.

The appropriate printout can be selected by pressing the corresponding softkey. The PRINT softkey configuration menu is shown below.

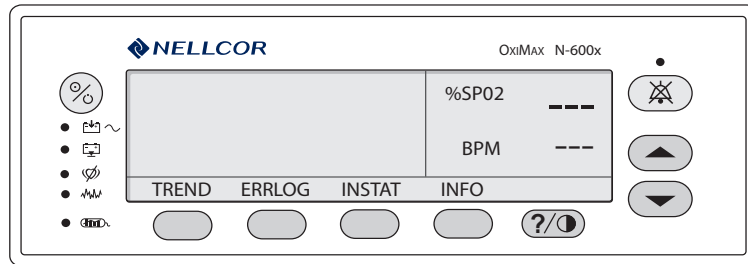

Up to 48 hours of trend data can be viewed on the printouts described below. When the monitor is turned on, trend data is recorded every four seconds. As an example, an instrument that is used six hours a week takes approximately eight weeks to fill the memory.



Note: The two-letter codes and the symbols that occur in the printout are described in Table 22 on page 143.

Trend Softkey

A Trend printout includes all data recorded for up to 48 hours of monitoring since the last Delete Trends was performed. A new trend point is recorded every four seconds. The figure below is an example of a Trend printout.

N-600x	VERSION X.X.X.X	TREND	SpO2 Limit: 30-100%	PR Limit: 100-180BPM
	ADULT	OSAT-S	SPO2 RESP MODE: NORMAL	
TIME		%SpO2	PR (bpm)	PA
01-JAN-06	14:00:00	100	120	220
01-JAN-06	14:00:05	100	124	220
01-JAN-06	14:00:10	100	190	220
01-JAN-06	14:00:15	100	190	220
01-JAN-06	18:00:43	---	---	---
01-JAN-06	18:00:48	---	---	---
N-600x	VERSION X.X.X.X	TREND	SpO2 Limit: 30-100%	PR Limit: 100-180BPM
	ADULT	OSAT-S	SPO2 RESP MODE: NORMAL	
TIME		%SpO2	PR (bpm)	PA
01-JAN-06	18:00:53	---	---	---
01-JAN-06	18:00:58	---	---	---
01-JAN-06	18:01:03	98	100	140
01-JAN-06	18:01:08	98	181*	190
01-JAN-06	18:01:13	99	122	232
Output Complete				

The first row of the printout includes information about the type of instrument delivering the information, the software level, type of printout, and alarm parameters. The second line lists the headings for the columns. These lines are printed out every 25 lines, or when a change to an alarm limit is made.

Patient data is represented with a date and time stamp for the data. In the example above, the [- - -] means that an *OXIMAX* sensor was connected but the signal quality of the data being received was too low for the monitor to interpret the data. Patient data that is outside of an alarm limit is marked with an asterisk (*).

At the end of the printout “Output Complete” prints indicating the data is not corrupt. If the Output Complete statement is not printed at the end of the printout, the data must be considered invalid.

ERRLOG Softkey

The ERRLOG softkey should only be used by Nellcor's Customer Service Engineering.

A list of all the errors recorded in memory can be obtained by pressing the ERRLOG softkey. The first line lists the type of instrument producing the printout, software level, type of printout, and the time of the printout. The second line of the printout consists of column headings. If nothing prints out, there have been no errors. An example of an ERRLOG printout is shown below.

N-600x	VERSION X.X.X.X		Error Log		Time:	14600:00:07
Time	Error	Task	Module	File	Line	Count
10713:21:03	269	6	24	1	764	1
00634:26:01	17	6	24	1	714	178
Output Complete						

INSTAT Softkey

The INSTAT softkey is for Nellcor's Customer Service Engineering only.

The DELETE softkey, described in the *OxIMAX N-600x Operator's Manual*, deletes the most recent trend data. The current trend data, along with the deleted trends, can be retrieved from the instrument through an Instat printout.

The oldest deleted trend is Trend 01 on the Instat printout. If a Trend 01 already exists in memory from an earlier Delete, the next deleted trend will become Trend 02. Each time DELETE is pressed, the number of existing trends increases by 1. The current trend has the largest trend number.

In the INSTAT printout below, line one is for instrument type, software revision level, type of printout, and alarm parameter settings. The second line contains the column headings. A trend point is recorded for every four seconds of instrument operation. Up to 48 hours of instrument operation data can be recorded.

N-600x	VERSION X.X.X.X	Instat	SpO2 Limit: 30-100%	PR Limit: 100-180BPM	
	ADULT	0SAT-S	SPO2 RESP MODE: NORMAL		
TIME	Trend 01	%SpO2	BPM	PA	Status
01-JAN-06	14:00:00	---	---	---	SD
01-JAN-06	14:00:05	---	---	---	PS
01-JAN-06	14:00:10	100	120	220	
01-JAN-06	14:00:15	100	120	220	
N-600x	VERSION X.X.X.X	Instat	SpO2 Limit: 80-100%	PR Limit: 60-180BPM	
	ADULT	0SAT-S	SPO2 RESP MODE: NORMAL		
TIME	TREND 02	%SpO2	BPM	PA	Status
01-JAN-06	14:24:24	79*	58*	220	PS SL PL
01-JAN-06	14:24:29	79*	57*	220	PS SL PL
01-JAN-06	14:24:29	0*	0*	---	PS LP SL PL
N-600x	VERSION X.X.X.X	Instat	SpO2 Limit: 80-100%	PR Limit: 60-180BPM	
	ADULT	0SAT-S	SPO2 RESP MODE: NORMAL		
TIME	TREND 03	%SpO2	BPM	PA	Status
01-JAN-06	7:13:02	99	132*	220	PH
01-JAN-06	7:13:07	99	132*	220	PH
01-JAN-06	7:13:12	99	132*	220	PH
01-JAN-06	7:13:17	99	132*	220	PH
01-JAN-06	7:13:22	99	132*	220	PH
01-JAN-06	7:13:27	99	132*	220	PH
01-JAN-06	7:13:32	99	132*	220	PH
Output Complete					

If the final line on the printout shows “Output Complete,” then the data has been successfully transmitted with no corruption. If there is no “Output Complete” line printed, the data should be considered invalid.

INFO Softkey

The INFO softkey is used by Nellcor’s Customer Service Engineering only.

Pressing the INFO softkey produces a single line printout of instrument information as illustrated below. The data presented in the printout from left to right, is the instrument type (*N-600x*), software version level, type of printout (INFO), CRC (Cyclic Redundancy Check) number, and ratio of current operating time to total operating time (the ratio itself has no units of measure).

N-600x	Version	XXXXXX	INFO	CRC:XXXX	SEC: 123456789/987654321
--------	---------	--------	------	----------	--------------------------

Next Softkey Menu

Additional options can be accessed from the Service Functions Main menu by pressing the NEXT softkey. When NEXT is pressed, the softkeys change to the functions shown below.

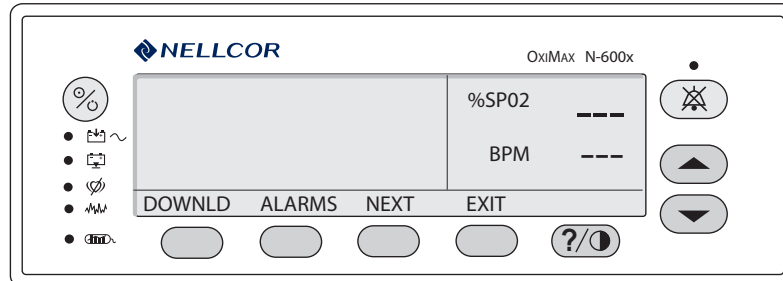

DOWNLD Softkey

The DOWNLD softkey is used to display the revision of the Boot Code. To exit DOWNLD, cycle power to the instrument by pressing the ON/STANDBY button. Consult the *Directions for Use (DFU)* provided with any downloads or upgrades to the FLASH firmware.

The baud rate for downloading new software is 19,200 via the data port.

ALARMS Softkey

The ALARMS softkey can change characteristics of the audible alarm. When the ALARMS softkey is pressed, the softkey's functions change as shown below.

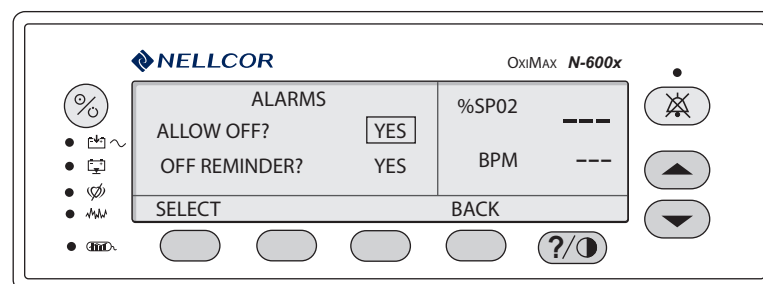

SELECT Softkey

The SELECT softkey is used to select which function of the audible alarm changes. A box can be cycled between ALLOW OFF and OFF REMINDER.

Use the following procedure to select and set the monitor's ALLOW OFF and OFF REMINDER:

1. Disconnect the *OxiMAX* sensor from the monitor.



Note: If the *OxiMAX* sensor is connected, the only softkeys on the monitor's screen display are PARAM and EXIT.

2. Simultaneously press the LIGHT softkey and the HELP/CONTRAST button until the menu bar changes to the softkey headings shown below.

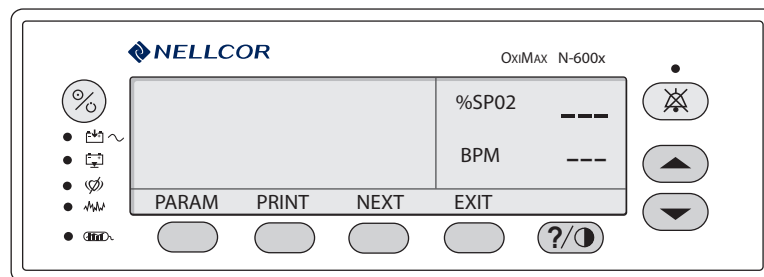

3. Press the NEXT softkey.

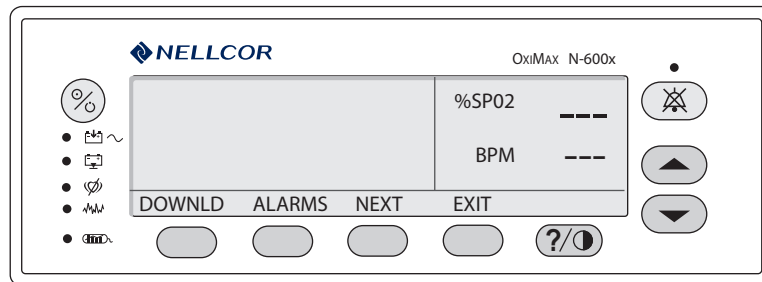

4. Press the ALARMS softkey.

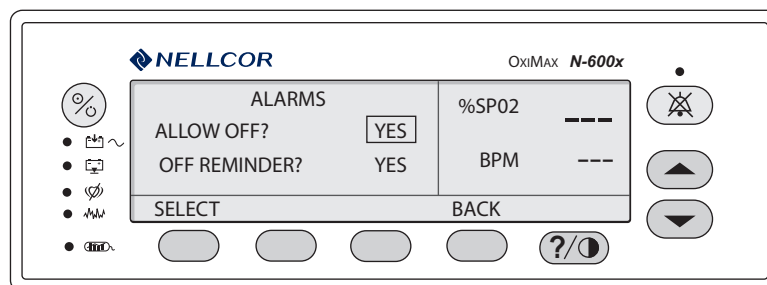

5. Use the SELECT softkey to toggle between ALLOW OFF? and OFF REMINDER?
6. Use the ADJUST UP or ADJUST DOWN button to change selected parameter.
7. Press the BACK softkey.

The ALLOW OFF softkey provides a choice between enabling or disabling the AUDIBLE ALARM OFF option. Pressing the ADJUST UP or ADJUST DOWN button cycles between YES and NO. If YES is selected, the operator has the option of selecting AUDIBLE ALARM OFF. If NO is selected, the operator is not given the option of selecting AUDIBLE ALARM OFF as an alarm silence duration choice.

If the audible alarm is set to OFF, a reminder tone can be sounded every three minutes to notify the user of this condition. The ADJUST UP and ADJUST DOWN buttons can be used to change the choice from YES to NO. Selecting YES enables the Reminder. Selecting NO disables the Reminder when the audible alarm is set to OFF.



WARNING: Audible alarms should not be silenced if patient safety could be compromised.

BATTERY Softkey

The BATTERY softkey places the monitor into shelf-mode while the monitor is in storage in order to preserve the life of the battery. This feature will be available in future releases of the *OXIMAX N-600x* monitor.

Setting Institutional Defaults (Sample)

Power-up default values may be changed to institutional power-up default values. Set the desired limits in the normal operation mode and set the institutional defaults in the monitor's service mode. The following default values may be set:

Table 5: Institutional Default Settings

Parameter	Setting
ALARM SILENCE Duration	OFF, 30, 60, 90, 120 seconds (Service Mode settings only)
Alarms	Allow Off - Yes/No
Alarm Volume	1 to 10 (min 45dB, max > 85dB)
Sensor Event Record Type	%SpO ₂ , %SpO ₂ + BPM, Default
Nurse Call Priority RS-232	normally high, normally low
Pulse Beep Volume	0 to 10
Pulse Rate Upper Alarm Limit	Lower Limit plus 1 to 250 BPM
Pulse Rate Lower Alarm Limit	20 BPM to Upper Limit minus 1
<i>SatSeconds</i>	OFF, 10, 25, 50, 100 seconds
Allow <i>SatSeconds</i>	Yes/No
Sensor Adjust Enable	Yes/No
Data Port Baud Rate	2400, 9600, 19200
Data Port Mode	ASCII, OXINET, CLINICAL, GRAPH, PHILIPS, GE MARQUETTE, DATEX OHMEDA AS/3 monitors. Available selections depend on the software installed in your monitor.
SpO ₂ Upper Alarm Limit	Lower Limit plus 1 to 100%
SpO ₂ Lower Alarm Limit	Upper Limit minus 1 to 85%

To set institutional defaults:

1. Disconnect the *OxiMAX* sensor from monitor.



Note: If the *OxiMAX* sensor is not disconnected, the only softkeys on the screen will be PARAM and EXIT.

2. Set desired parameters to the institutional values. Refer to the *OxiMAX N-600x Operator's Manual* for parameter values.
3. Simultaneously press the LIGHT softkey and the HELP/CONTRAST button until the softkey headings appear as shown below.

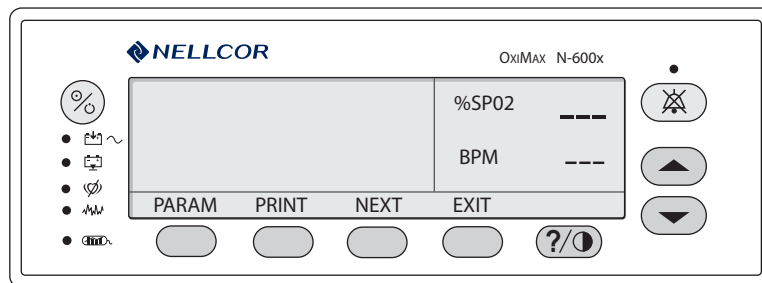

4. Press the PARAM softkey.

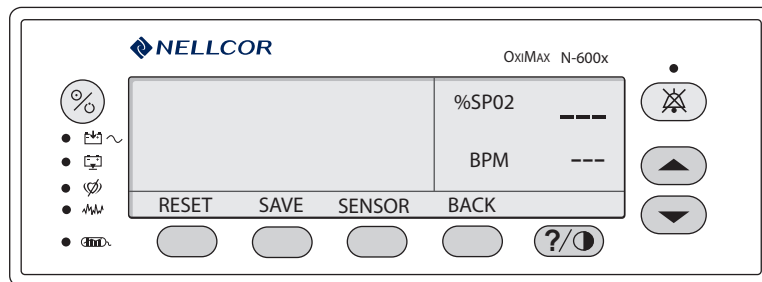

5. Press the SAVE softkey.

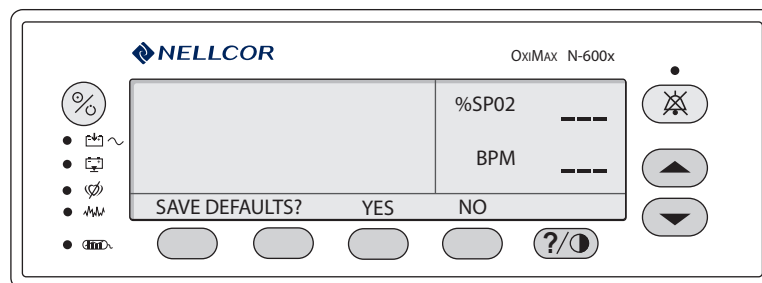

6. Press the YES softkey. The monitor sounds three beeps indicating the defaults have been saved.

Troubleshooting

Overview

This chapter describes how to troubleshoot common problems. The tables listed below provide possible monitor difficulties, causes, and recommended solutions.

Use this section in conjunction with *Performance Verification* on page 15, and *Spare Parts* on page 103. Follow the instructions described in *Disassembling the Monitor* on page 83 to remove and replace a part suspected to be defective.

Performing Repairs

Only qualified service personnel should open the monitor housing, remove and replace components, or make adjustments. If your medical facility does not have qualified service personnel, please contact Nellcor's Technical Services or your local Nellcor representative.

Problem Resolution

Problems that may occur with the *N-600x* are categorized in Table 6. Refer to the paragraph indicated for additional troubleshooting instructions.

Table 6: Problem Categories

Symptoms	Recommended Actions
1. Power <ul style="list-style-type: none"> • No power using AC and/or DC power source. • Fails power-on self-test. • Powers down without any apparent cause. 	See <i>Power</i> on page 65.
2. Buttons <ul style="list-style-type: none"> • Monitor does not respond properly to buttons being pressed. 	See <i>Buttons</i> on page 66.

Table 6: Problem Categories

Symptoms	Recommended Actions
<p>3. Display/Alarms</p> <ul style="list-style-type: none"> • Display does not respond properly. • Alarms and other tones do not sound properly or are generated without apparent cause. 	<p>See <i>Display/Alarms</i> on page 67.</p>
<p>4. Operational Performance</p> <ul style="list-style-type: none"> • Display appears to be operational, but monitor shows no readings. • Suspect readings. 	<p>See <i>Operational Performance</i> on page 68.</p>
<p>5. Data Port</p> <ul style="list-style-type: none"> • <i>N-600x</i> data port not functioning properly. 	<p>See <i>Data Port</i> on page 69.</p>

Power

Power problems are related to AC and/or DC. Table 7 lists recommended actions to power problems.

Table 7: Power Problems

Symptoms	Recommended Actions
<p>Low Battery indicator lights steadily while <i>N-600x</i> is connected to AC and the battery is not discharged.</p>	<ul style="list-style-type: none"> • Ensure the <i>N-600x</i> is plugged into an operational AC outlet and the AC indicator is lit. • Check the fuses. The fuses are located in the Power Entry Module as indicated in <i>Replacing the Fuse</i> on page 84. Replace if necessary. Open the monitor as described in <i>Disassembling the Monitor</i> on page 85. Install a new battery and verify the charging voltage output to the battery while on AC power when first turning on the monitor. The charging voltage increases to 7.05 - 7.35 volts if the battery is good, the charging voltage decreases over time. Replace the power supply if the above charging values are not met. • Check the harness connection from the bottom enclosure to the Main Board PCB, as instructed in <i>Main Board PCB Replacement</i> on page 97. If the connection is good, replace the Main Board PCB.
<p>The <i>N-600x</i> generates an error code when disconnected from AC power, and the monitor is powered up.</p>	<p>The battery may be discharged. To recharge the battery, refer to <i>Battery Charge</i> on page 16. The monitor may be used with a less than fully charged battery but with a corresponding decrease in operating time from that charge. The battery may be defective.</p>
<p>Low Battery indicator on during DC operation and an alarm is sounding.</p>	<p>There are less than 15 minutes remaining of usable charge left on the <i>N-600x</i> battery before the instrument shuts off. At this point, if possible, cease use of the <i>N-600x</i> on battery power, connect it to an AC source and allow it to recharge (approximately eight hours). The <i>N-600x</i> may continue to be used while it is recharging. (A full recharge of the battery while the monitor is being used takes 12 hours.)</p>

Table 7: Power Problems

Symptoms	Recommended Actions
Battery does not charge.	<ul style="list-style-type: none"> • Replace battery if it is more than two years old. • If the battery fails to hold a charge, replace the battery as indicated in <i>Battery Replacement</i> on page 88. • Open the monitor as described in <i>Disassembling the Monitor</i> on page 83. Replace a new battery and verify the charging voltage output to the battery while on AC when first turning the monitor ON. The charging voltage will climb between 7.05 to 7.35 volts. Since the battery is good, the charging voltage will decrease with time. Replace power supply if above values are not met.

Buttons

Table 8 lists symptoms of problems relating to non-responsive buttons and recommended actions. If the action requires replacement of a PCB, refer to *Disassembling the Monitor* on page 83.

Table 8: Button Problems

Symptom	Recommended Action
Buttons do not respond when the unit is turned on.	<ul style="list-style-type: none"> • Replace the Main Board PCB. See <i>Main Board PCB Replacement</i> on page 97. • If the buttons still do not work, replace the Top enclosure assembly. See <i>Top Case Assembly Replacement</i> on page 102.

Display/Alarms

Table 9 lists symptoms of problems relating to non-functioning displays and audible tones or alarms, and recommended actions. If the action requires replacement of a PCB or module, refer to *Disassembling the Monitor* on page 85.

Table 9: Display/Alarms Problems

Symptom	Recommended Action
Display values are missing or erratic.	<ul style="list-style-type: none"> • If the <i>OxIMAX</i> sensor is connected, replace the pulse oximetry cable. • If the condition continues, replace the <i>OxIMAX</i> sensor. • If the condition persists, replace the Main Board printed circuit board. See <i>Main Board PCB Replacement</i> on page 97.
Display pixels do not light.	<ul style="list-style-type: none"> • Check the connection between the Main Board PCB and the Display PCB. • If the condition continues, replace the Display PCB. See <i>Display PCB Replacement</i> on page 95. • If the condition persists, replace the Main Board PCB. See <i>Main Board PCB Replacement</i> on page 97.
Alarm sounds for no apparent reason.	<ul style="list-style-type: none"> • Moisture or spilled liquids can cause an alarm to sound. Allow the monitor to dry thoroughly before using. • If the condition persists, replace the Main Board PCB. See <i>Main Board PCB Replacement</i> on page 97.
Alarm does not sound.	<ul style="list-style-type: none"> • Check the alarm silence status. • Check the speaker connection. • Replace the speaker as described in <i>Alarm Speaker Replacement</i> on page 99. • If the condition persists, replace the Main Board PCB. See <i>Main Board PCB Replacement</i> on page 97.
Primary speaker fails and a slow, high-pitched tone sounds.	<ul style="list-style-type: none"> • Press the HELP/CONTRAST button and follow the on-screen messages.

Operational Performance

Table 10 lists symptoms of problems relating to operational performance (no error codes displayed) and recommended actions. If the action requires replacement of a PCB or module, refer to *Disassembling the Monitor* on page 85.

Table 10: Operational Performance Problems

Symptom	Recommended Action
<p>The Pulse Amplitude indicator seems to indicate a pulse, but displays zeroes.</p>	<ul style="list-style-type: none"> • The <i>OxIMAX</i> sensor may be damaged; replace the sensor. • If the condition persists, replace the Main Board PCB. See <i>Main Board PCB Replacement</i> on page 97.
<p>%SpO₂ or Pulse values change rapidly; Pulse Amplitude indicator is erratic.</p>	<ul style="list-style-type: none"> • The <i>OxIMAX</i> sensor may be damp or may have been reused too many times. Replace the sensor. • An electrosurgical unit (ESU) may be interfering with performance: <ul style="list-style-type: none"> - Move the monitor and its cables and <i>OxIMAX</i> sensors as far from the ESU as possible. - Plug the monitor power supply and the ESU into different AC circuits. - Move the ESU ground pad as close to the surgical site as possible and as far away from the <i>OxIMAX</i> sensor as possible. • Verify the performance with the procedures detailed in <i>Performance Verification</i> on page 15. • If the condition persists, replace the Main Board PCB. See <i>Main Board PCB Replacement</i> on page 97.

Data Port

Table 11 lists symptoms of problems relating to the data port and recommended actions. If the action requires replacement of the Main Board PCB, refer to *Disassembling the Monitor* on page 85.

Table 11: Data Port Problems

Problem	Resolution
No printout received.	<ul style="list-style-type: none"> • Confirm the printer is working through an alternate means. • The monitor's baud rate does not match the printer. Change the baud rate of the monitor following instructions in <i>Configuring the Data Port</i> on page 127. • If the condition persists, replace the Main Board PCB. See <i>Main Board PCB Replacement</i> on page 97.
The RS-232 nurse call is inoperable.	<ul style="list-style-type: none"> • Verify the connections are made between pins 5 (GND) and 11 (nurse call) of the data port (Figure 16 on page 136). • Verify the output voltage between ground pin 5 and pin 11 is -5 to -12 VDC (no alarm) and +5 to +12 VDC (during alarm) (Figure 16 on page 136). • If the condition persists, replace the Main Board PCB. See <i>Main Board PCB Replacement</i> on page 97.

On-Screen Help

The *N-600x* monitor is equipped with an on-screen help system which enables you to browse and navigate through multiple help topics. Follow the steps outlined below to access and utilize the on-screen help.

Accessing Multiple Topics

You can access multiple on-screen help topics and select a specific topic to view.

Follow the example described below to access the *SatSeconds* help topic.

To access multiple help topics:

1. From the Main menu, press the HELP/CONTRAST button. The HELP MAIN window appears.

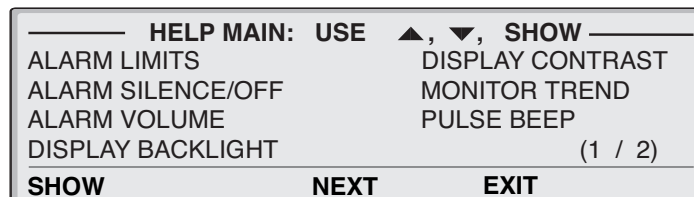

2. Press the ADJUST UP or ADJUST DOWN button to scroll through the available help topics or press NEXT to access page (2 / 2). Page (2 / 2) of the HELP MAIN window appears.

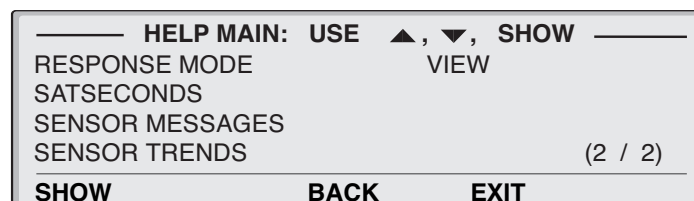

3. From page (2 / 2) of the HELP MAIN window, press ADJUST DOWN to select SATSECONDS and then press SHOW. The HELP SATSECONDS

window appears. The *SatSeconds* help topic contains a total of six (6) consecutive help windows.

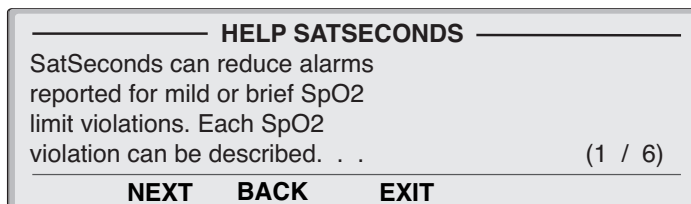

4. Press the NEXT softkey to scroll through each window of the selected help topic.

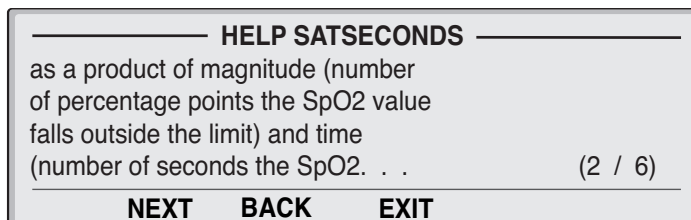

5. Press NEXT.

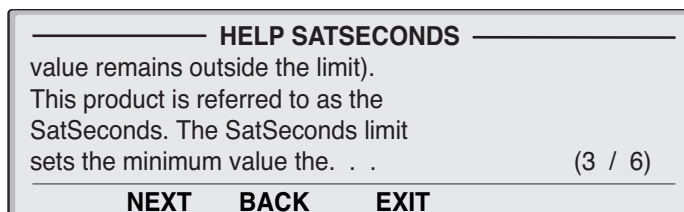

6. Press NEXT.

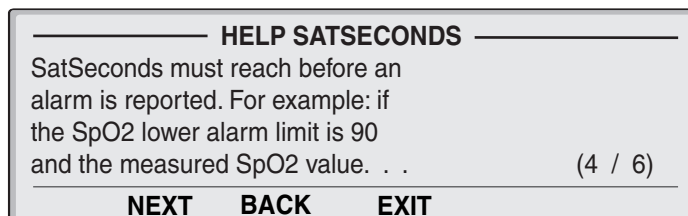

7. Press NEXT.

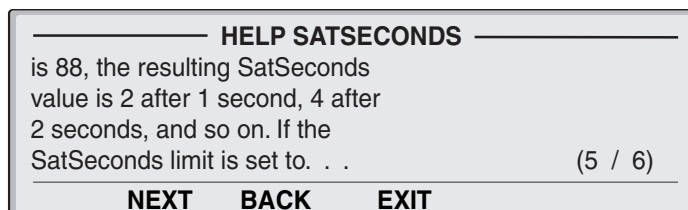

8. Press NEXT.

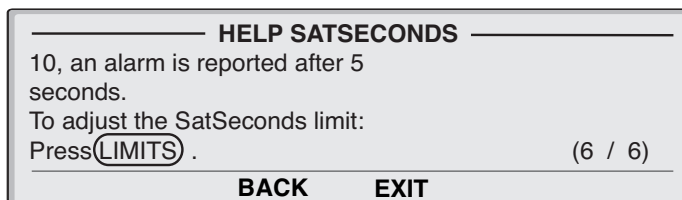

9. Press BACK to view the previous windows. Continue to press BACK to return to the HELP MAIN window.

10. Press EXIT to return to the monitor's Main menu.

Accessing Single Topics

The on-screen help enables you to access single topics by pressing the HELP/CONTRAST button from a monitor submenu.

Follow the example described below to access the *SatSeconds* help topic.

To access single help topics:

1. Press LIMITS on the monitor Main menu and then SELECT to highlight SAT-S (*SatSeconds*).
2. Press the HELP/CONTRAST button. The HELP LIMITS window appears.

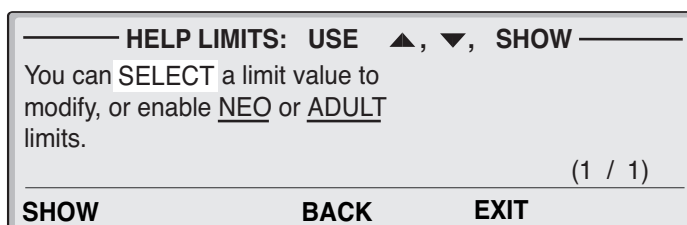

3. Press ADJUST UP or ADJUST DOWN to highlight an available help topic (SELECT, NEO and ADULT). For this example, highlight SELECT.

4. Press SHOW. The HELP LIMITS SELECT window appears.

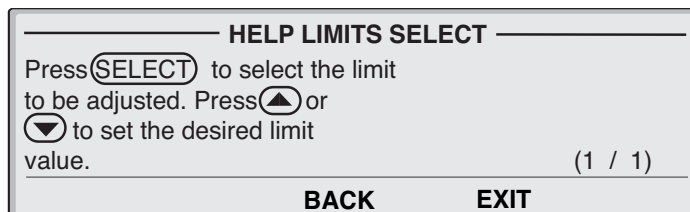

5. Press BACK.
6. Press ADJUST DOWN to highlight NEO and then press SHOW. The HELP LIMITS NEO window appears.

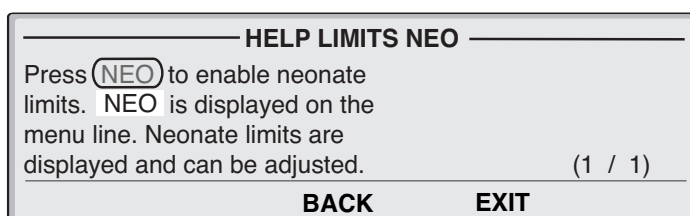

7. Press BACK.
8. Press ADJUST DOWN to highlight ADULT and then press SHOW. The HELP LIMITS ADULT window appears..

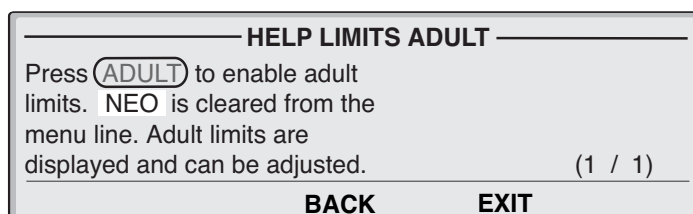

9. Press EXIT to return to the LIMITS display.

Error Codes

An error code is displayed when the monitor detects a non-correctable failure. Table 12 provides a list of error codes for the monitor. When one of the following errors occurs:

- the monitor sounds a low priority alarm that cannot be silenced except by power-down
- measurements stop
- remove all information from the screen and display the message EEE followed by an error code
- cycling the power clears the displayed error code

Table 12: Error Codes

Error Code	Description
1	%SpO2 front end RAM error.
2	%SpO2 front end ROM/code integrity error.
3	%SpO2 front end reported a bad Cyclic Redundancy Check (CRC).
4	%SpO2 front end reported FSP message not allowed.
5	%SpO2 front end reported illegal value sent in FSP message %SpO2 front end.
6	%SpO2 front end reports calibration (offset) failure.
9	%SpO2 front end reported syntax error in FSP message.
10	Over-current limit in %SpO2 front end has tripped.
11	%SpO2 front end reports incorrect system voltage.
12	%SpO2 front end reports other hardware problem.
14	%SpO2 front end reports communication channel overflow.
16	%SpO2 front end reports watch dog time out.
17	%SpO2 front end reports that sensor appears defective.
18	%SpO2 front end reports internal register appears modified from expected value.
19	%SpO2 front end reports signal out-of-range.
48	%SpO2 front end reports spurious interrupt.
49	%SpO2 front end reports internal buffer overflow.
50	%SpO2 front end reports intermittent error.
51	%SpO2 front end reports digital communications error.

Table 12: Error Codes

Error Code	Description
52	%SpO2 front end reports warmer error.
53	Front end data not received.
54-128	Reserved for future front end object errors.
129-171	Unexpected LPS error (LPS recovered from this error).
172-255	Reserved for future front end object errors.
256	%SpO2 back end reports beginning of packet missing.
257	%SpO2 back end reports packet start ID (SID) missing.
258	%SpO2 back end reports packet length error.
259	%SpO2 back end reports message length error.
260	%SpO2 back end reports packet contains unsupported key.
261	%SpO2 back end reports packet CRC error.
262	%SpO2 back end reports end of packet missing.
263	%SpO2 back end reports packet contains undefined key.
264	%SpO2 back end reports corrupted variable.
265	%SpO2 back end reports memory overflow.
266	%SpO2 back end reports bad pointer.
267	%SpO2 back end reports parameter value out-of-range.
268	%SpO2 back end reports reset detected.
269	%SpO2 back end reports unexpected value.
270	%SpO2 back end reports time-out.
271	%SpO2 back end reports not ready/not initialized.
272	%SpO2 back end reports double fault.
273	%SpO2 back end reports date out-of-range error.
274	%SpO2 back end reports incompatible software version.
275	%SpO2 back end reports incorrect registration number.
276	%SpO2 back end reports sensor read failure.
277	%SpO2 back end reports sensor signature verification fails.
278	%SpO2 back end reports warmed sensor temperature set point failure.
279	%SpO2 back end reports warmed sensor / %SpO2 front end incompatible.
280	%SpO2 back end reports does not support feature required by sensor.

Table 12: Error Codes

Error Code	Description
281	%SpO2 back end reports overflow/underflow.
282	%SpO2 back end reports sensor activation failure.
283	%SpO2 back end reports sensor write failure.
284	ECG trigger error.
285	Sensor trend not open.
286	Sensor trend already open.
287	Sensor trend data unavailable.
288	All sensor trend data read.
289	Incompatible private label.
290-511	Reserved for future back end for future back end object errors.
512	General failure of UIF Module generic post.
512	Dead battery/Missing battery.
514	Real time clock is non-operational.
515	Application code is not present in the Flash.
516	Invalid Flash type.
517	Serial clock line is not toggling or is toggling at an incorrect rate.
518	Application program is corrupt.
519	Invalid Nell-1A version.
520	Error in the start up sequence.
521	OS multi-tasking service failure.
522	A state machine has received an unknown state transition.
523	The operation just attempted was not completed successfully - for example, Institutional Defaults could not be reset.
524	An unexpected value was received - for example, an out-of-range parameter was passed to a function.
525	EEPROM CRC failure.
526	%SpO2 module not responded.
527	Institutional parameters lost - e.g. for UIF: Institutional EEPROM section CRC corrupt.
528	Current settings lost - e.g. for UIF: Institutional EEPROM section CRC corrupt.
529	Critical low battery.
530	Low battery error.

Table 12: Error Codes

Error Code	Description
531	External watchdog failure.
532	Power PC watchdog failure.
533	Boot NVRAM uninitialized error.
534	Failed CRC check of application code in flash.
535	Failed periodic ram CRC check on application code running in RAM.
560	Memory corruption detected.
561	RTOS Resource unavailable.
562	%SpO ₂ front end reset.
563	%SpO ₂ reported error.
564	Clinical mode was exited after input was received.
565	Communication failures between software modules.
566	Excessive resets before UIF runs.
567	An unexpected interrupt has been asserted.
568	General failure in UIF module generic post.
569	BOOT application program is corrupt - CRC does not match.
570	RTC was restarted.
574	Excessive restarts within one minute.
575	Trend data corrupted
576	Logic Processing Board (LPS) is going through excessive resets.
577	LPS status messages not arriving in a timely manner.
578	LPS driver has received too many corrupt (protocol error) messages.
579	Status report AC OK bit does not equal the hardware AC OK signal.
580	LPS driver received only a partial LPS message.
581	Too many corrupt (invalid data) message.
582	Unable to enter shelf-mode, this could mean that the LPS is dead or there is a serial port transmit problem.
583	Primary speaker failure detected.
650	Oximetry module reports internal software consistency check failed.
651	Oximetry module reports software functions executed before initialization completed.
652	Oximetry module reports internal memory buffer overflow.
653	Oximetry module reports host reset.

Table 12: Error Codes

Error Code	Description
654	Oximetry module ROM/Code integrity error.
655	Oximetry module RAM error.
656	Oximetry module reports background self-test failed to complete in the allocated time.
657	Oximetry module reports a state machine is in an unexpected state.
658	Oximetry module reports memory corruption detected.
659	Oximetry module reports spurious interrupt detected.
660	Oximetry module reports unable to issue commands to %SpO2 front end.
661	Oximetry module reports unable to write to external Flash.
662	Oximetry module reports communication with %SpO2 front end lost.
663	Oximetry module reports internal register modified from expected value.
701	POST external hardware failsafe circuit error.
702	POST PWR_ENA fail.
703	Unknown state machine # or charge state.
704	Unexpected interrupt.
705	Stack over/under error.
706	ROM CRC error - POST or background.
707	POST RAM error.
708	Unexpected reset.
709	Unexpected internal WD instance #1.
710	Unexpected internal WD instance #2.
711	Unexpected internal WD instance #3.
712	Unexpected internal WD instance #4.
713	Unexpected internal WD instance #5.
714	Unexpected internal WD instance #6.
715	LINE_V & AC_OK disagree.
716	POST Internal WD circuit error.
717	Battery shorted with AC power.
718	Battery open with AC power.
719	EEPROM W/R failure - POST or background.
720	Battery charger error - instance #1.

Table 12: Error Codes

Error Code	Description
721	Battery charger error - instance #2.
722	Battery charger error - instance #3.
723	Battery charger error - instance #4.
724	Battery charger error - instance #5.
725	Battery charger error - instance #6.
726	Battery charger error - instance #7.
727	Battery charger error - instance #8.
728	Battery charger error - instance #9.
729	Battery critical without AC power.
730	Battery fail without AC power.
731	EEPROM CRC Error - EEPROM cleared.
732	Vref error on DC.
733	Vref error on AC.
734	Overtemperature (> 58 C).
735	Battery I charge.
736	Battery I discharge.
737	Temperature low.
738	Hardware failsafe occurred, maybe overtemperature.
739	Hardware failsafe occurred, maybe overcurrent.
740	Hardware failsafe occurred, cause unknown.
741	Message RX CRC error.
743	Error in the shut down sequence - occurs if the power is cycled off and on too quickly.

Additional Messages

In addition to the error codes listed in Table 12, the following messages may be encountered:

Table 13: Additional Display Messages

Message	Description
Adjust Contrast Up, Down	An attempt to adjust the contrast of the display by pressing and holding the HELP/CONTRAST button.
Battery Cannot Be Fully Charged - Replace Battery	The battery is defective old and can no longer be fully charged. We recommend replacing the battery completely.
Clock Settings Lost	Appears if the monitor detects the real time clock has stopped running. This occurs when both the battery and AC power are lost.
Data-In OXIMAX Sensor	The <i>OXIMAX</i> sensor containing sensor event record data is connected to the monitor.
Data Type: %SpO2	A blank <i>OXIMAX</i> is connected to a monitor with Data Type set to %SpO2.
Data Type: Event/ %SpO2 + BPM	A blank <i>OXIMAX</i> sensor is connected to a monitor with Data Type set to %SpO2 + BPM.
Defaults Lost	Monitor detects the power-on settings have been lost.
Delete Trend?	An attempt to delete trend data from memory by pressing the DELETE softkey.
Help Speaker Failure	Note: Once this monitor is powered off, it cannot be powered on again.
Invalid Blip Vol	An attempt to save current settings as power-on defaults and the BLIP volume is 0.
Invalid Silence Duration	An attempt has been made to set the alarm silence duration power-on default to "OFF." The power-on default cannot be set to "OFF."
Invalid %SpO2 Limit	An attempt has been made to set either the upper or lower alarm limit power-on default below 85. The power-on default cannot be set below 85.
Low Battery	The internal battery needs to be recharged.
Primary Speaker Failure	Notify service personnel. Press HELP.
Reading Trends	The monitor is gathering trend information to display.
Reset Defaults?	An attempt to reset to factory defaults by pressing the RESET softkey on the Parameters menu, the monitor displays the options YES and NO.
Save Defaults?	An attempt to save the current settings as the power-on defaults by pressing the SAVE softkey on the Parameters menu, the monitor displays the options YES and NO.

Table 13: Additional Display Messages

Message	Description
Sensor Disconnected	The <i>OxIMAX</i> sensor has disconnected from the pulse oximetry cable, the cable has disconnected from the monitor, or the <i>OxIMAX</i> sensor/cable wiring is defective. Press the ALARM SILENCE button to silence the alarm. Check the connections. If this does not resolve the problem, replace the <i>OxIMAX</i> sensor and/or cable.
Settings Lost	Settings lost is displayed when the monitor detects the current settings have been lost.
Unit Will Shut Down If AC Power Is Lost	The battery is critically low, and if the AC power is lost, the monitor may power OFF.

Primary Speaker Failure

The *N-600x* may detect a failure of the primary speaker and sound a high-pitched, slow-pulsing piezo tone. A primary speaker failure message displays as shown below:

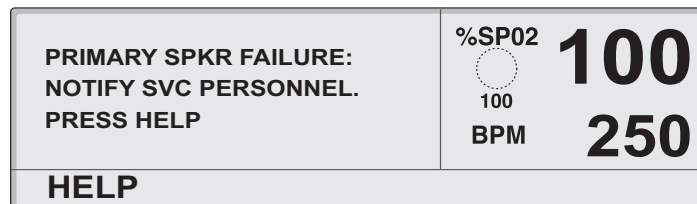

1. Press HELP to continue. The following message displays.

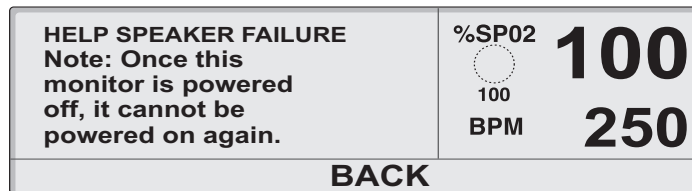

2. Press BACK to display the speaker failure message again. The message cannot be cleared.



WARNING: Pressing ALARM SILENCE will keep ALL alarms from sounding for the alarm silence duration period.

3. Press the ALARM SILENCE button to silence the slow-pulsing piezo tone.



Note: Once the monitor is silenced, the *N-600x* sounds a piezo tone every three minutes as a reminder of the primary speaker failure condition. The *N-600x* also sounds the piezo tone to annunciate low, medium and high priority alarms during this time. If an *N-600x* monitor is reporting a primary speaker failure is powered off, it cannot be powered on again.



WARNING: If an *N-600x* reports a primary speaker failure, do not use the monitor longer than necessary to ensure patient safety. Contact a qualified service personnel, your local Nellcor representative, or Nellcor's Technical Services Department for assistance.

Disassembling the Monitor

Overview

The monitor can be disassembled down to all major component parts, including:

- PCBs
- battery
- cables
- chassis enclosures

The following tools are required:

- small, phillips-head screwdriver
- medium, phillips-head screwdriver
- small blade screwdriver
- needle-nose pliers or 1/4-inch socket
- torque wrench, 10-in lbs. (1.13 Newton-meters)



WARNING: Before attempting to open or disassemble the N-600x, disconnect the power cord to avoid possible injury.



WARNING: No user serviceable parts inside.



Caution: Observe ESD (electrostatic discharge) precautions when working within the unit.



Note: Some spare parts are supplied with a business reply card. When you receive the spare parts, please fill out and return the business reply card.

Replacement Level

The supported replacement level for the *N-600x* monitor is to the printed circuit board (PCB) and major subassembly level. Once a suspected PCB is isolated, follow the procedures in *Disassembling the Monitor* on page 85, to replace the PCB with a known good PCB. Check to see if the symptom disappears and that the monitor passes all performance tests. If the symptom persists, swap back the replacement PCB with the suspected malfunctioning PCB (the original PCB installed when you started troubleshooting) and continue troubleshooting as directed in this section.

Replacing the Fuse

To replace the fuse:

1. Turn the monitor off by pressing the ON/STANDBY button.
2. Disconnect the monitor from the AC power source.
3. Disconnect the power cord from the back of the monitor.
4. Remove the fuse drawer from the power module by pressing down on the tab in the center and pulling out as shown in Figure 4.

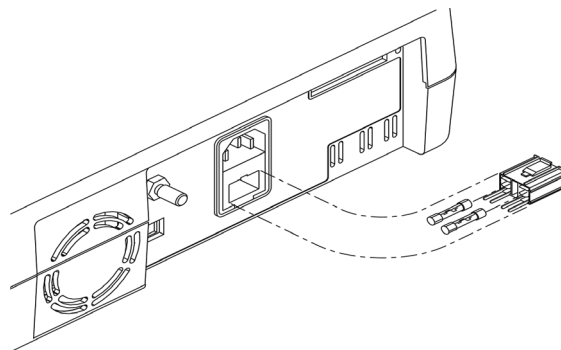

Figure 4: Fuse Removal

5. Put two (2) new, 5 x 20-mm, slow blow, 0.5-amp, 250-volt fuses in the drawer and reinsert the drawer in the power entry module.

Disassembling the Monitor

To disassemble the monitor:

1. Turn the monitor off by pressing the ON/STANDBY button.
2. Disconnect the monitor from the AC power source.
3. Set the monitor upside down on a static-free work surface.



Caution: Ensure the work surface is clean and free of debris.

4. Carefully set the monitor right-side up, preventing premature separation.
5. Separate the monitor's top and bottom cases, being careful not to stress the connection harnesses between the cases.
6. Place the two halves of the monitor on the static-free work surface.



Caution: To avoid stress or damage to the power supply wiring harness, ensure the top enclosure is lying flat on the work surface.

7. Remove the monitor's four corner screws.

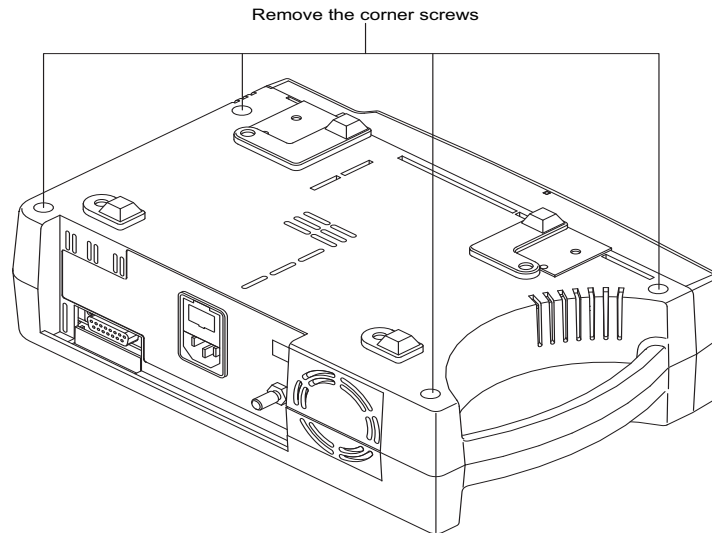

Figure 5: Removing the Corner Screws



Caution: Observe ESD (electrostatic discharge) precautions when disassembling and reassembling the *N-600x* and when handling any of the components of the *N-600x*.

8. Separate the monitor's top enclosure from the bottom, being careful not to stress the wire harnesses between the cases.
9. Place the two halves of the monitor on the table.

10. Disconnect the monitor's power supply harness from J200 on the Main Board PCB.

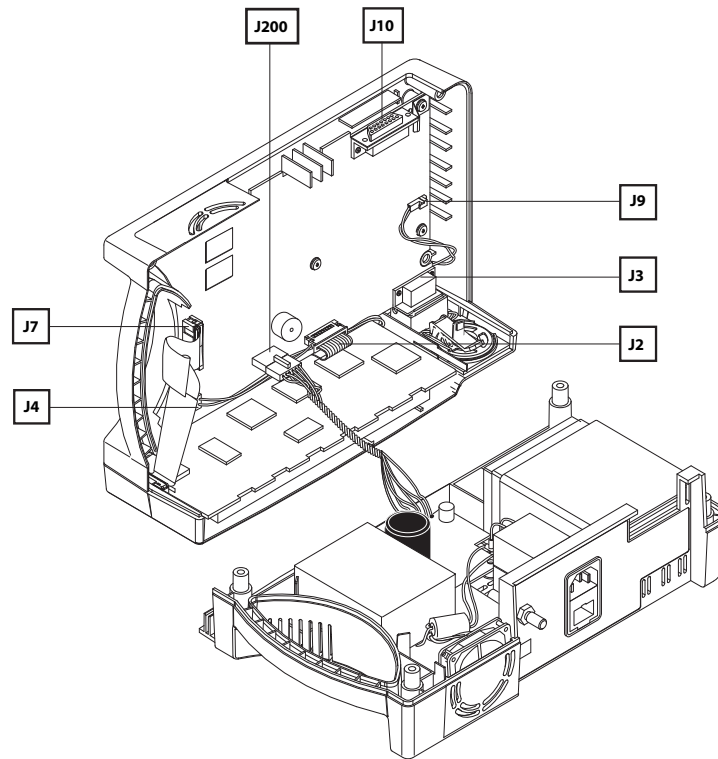

Figure 6: Opening the Monitor Casing

Assembling the Monitor

To assemble the monitor:

1. Connect the monitor's Power Supply to J200 on the Main Board PCB.
2. Place the monitor's top enclosure over the bottom case, being careful to align the Display PCB, Power Entry Module, and the fan with the slots in the monitor casing.



Caution: Ensure not to pinch any wires between the cases when reassembling the monitor. Inspect the entire edge of the union for even seating before installing the screws.

3. Place the screws in the bottom cover of the monitor and gently tighten the screws that hold the case halves together (10-in lbs. maximum).



Caution: Overtightening could strip out the screw holes in the top enclosure, rendering it unusable.

4. Replace the four corner screws.

Battery Replacement

Removing the Old Battery

To remove the old battery:

1. Turn the monitor off by pressing the ON/STANDBY button.
2. Disconnect the monitor from the AC power source.
3. Follow the steps in *Disassembling the Monitor* on page 85.
4. Remove the two screws from the battery bracket and lift the battery out of the bottom case as shown in Figure 7 on page 89.

5. Be sure to note the polarity of the leads. Use needle-nose pliers to disconnect the leads from the battery.

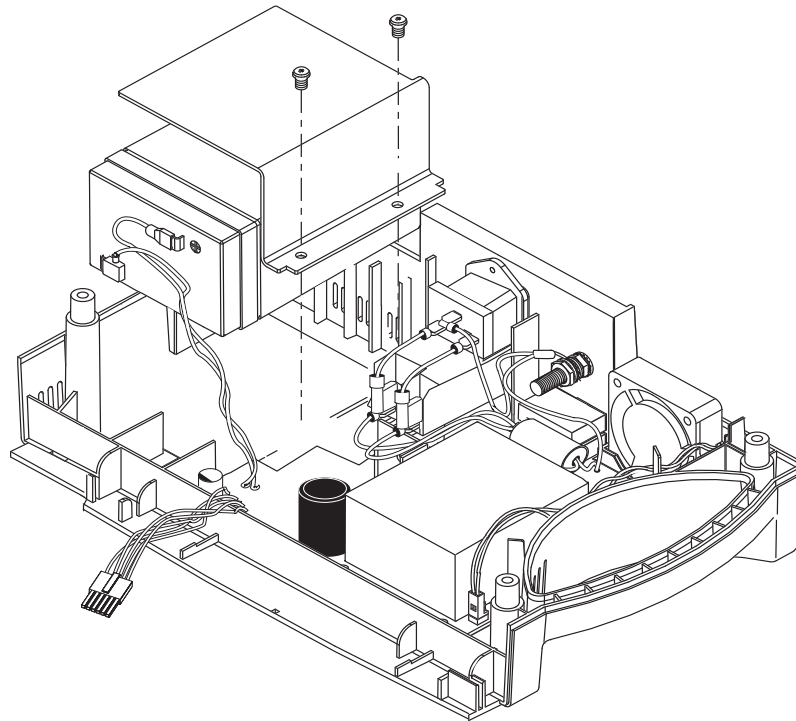

Figure 7: Removing the Battery



Caution: The lead-acid battery is recyclable. Do not dispose of the battery by placing it in the regular trash. Dispose of the battery in accordance with local guidelines or contact Nellcor's Technical Services department to arrange for disposal.

Replacing the Battery

To replace the old battery:

1. Follow the steps outlined in *Removing the Old Battery* on page 88.
2. Connect the leads to the battery. The red wire connects to the positive terminal, and the black wire connects to the negative terminal.
3. Insert the new battery into the bottom case with the negative terminal towards the outside of the monitor. Install the bracket and grounding lead with the two screws.

4. Follow the steps outlined in *Assembling the Monitor* on page 88.
5. Power the monitor on to verify proper operation.

Power Entry Module (PEM) Replacement

Removing the Power Entry Module

To remove the power entry module:

1. Turn the monitor off by pressing the ON/STANDBY button.
2. Disconnect the monitor from the AC power source and follow the steps outlined in *Disassembling the Monitor* on page 85.
3. Push the top of the Power Entry Module (PEM) in from the outside of the case, and lift up.
4. Use needle-nose pliers to disconnect the leads from the PEM shown in Figure 8.

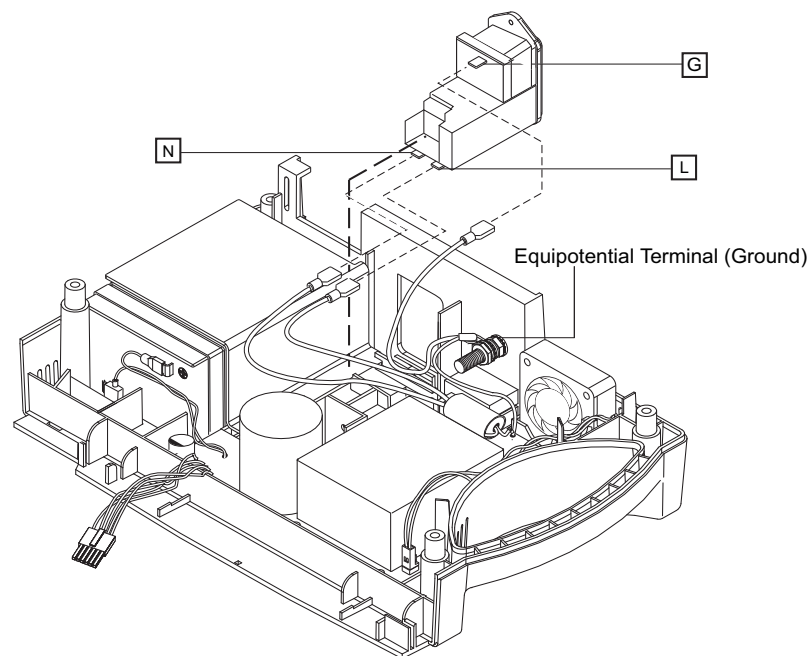

Figure 8: Power Entry Module

Replacing the Power Entry Module

To replace the power entry module:

1. Reconnect the three power supply leads as indicated in Table 14 on page 92.
2. Install the PEM in the bottom case with the fuse drawer facing down. A tab in the bottom case holds the PEM in place.
3. Insert the bottom wing of the PEM between the tab and the internal edge of the sidewall of the bottom case.
4. Push the PEM down and towards the outside of the monitor until it clicks into place.
5. Follow the steps in *Assembling the Monitor* on page 88.

Power Supply Replacement

Removing the Power Supply

To remove the power supply:

1. Turn the monitor off by pressing the ON/STANDBY button.
2. Disconnect the monitor from the AC power source and follow the steps outlined in *Disassembling the Monitor* on page 85.
3. Push the top of the Power Entry Module (PEM) in from the outside of the case, and lift up.
4. Use needle-nose pliers to disconnect the leads from the PEM shown in Figure 8.
5. Disconnect the fan wire harness from J1 on the Power Supply PCB shown in Figure 9 on page 92).

6. Use a 10mm wrench to disconnect the power supply ground lead from the equipotential terminal shown in Figure 8 on page 90.
7. Remove the seven screws shown in Figure 9 on page 92.
8. Lift the power supply out of the bottom case.

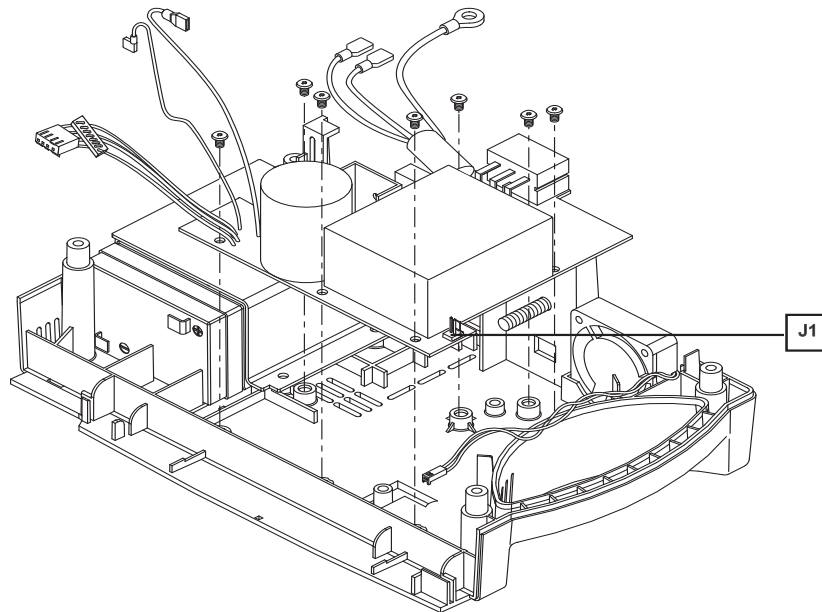

Figure 9: Power Supply

Replacing the Power Supply

To replace the power supply:

1. Reconnect the leads to the PEM following the instructions in Figure 14 on page 92, and Figure 8.

Table 14: Power Supply Lead Connections

Wire Color / Label	Connect To
Green & Yellow	Equipotential Lug
Brown/Labeled “L”	“L” on the Power Entry Module
Blue/Labeled “N”	“N” on the Power Entry Module
Red/Labeled “+”	Positive Battery Terminal
Black/Labeled “-”	Negative Battery Terminal

2. Place the power supply in the bottom case.



Caution: When installing the power supply, tighten the seven screws (4-in lbs maximum). Overtightening could strip out the screw holes in the bottom case, rendering it unusable.

3. Install the seven screws in the power supply and tighten.
4. Connect the fan harness to J1 on the power supply.
5. Install the PEM in the bottom case with the fuse drawer facing down. A tab in the bottom case holds the PEM in place.
6. Insert the bottom wing of the PEM between the tab and the internal edge of the sidewall of the bottom case.
7. Push the PEM down and towards the outside of the monitor until it clicks.
8. Follow the steps outlined in *Assembling the Monitor* on page 88.

Cooling Fan Replacement

Removing the Cooling Fan

To remove the cooling fan:

1. Turn the monitor off by pressing the ON/STANDBY button.
2. Disconnect the monitor from the AC power source and follow the steps outlined in *Disassembling the Monitor* on page 85.
3. Disconnect the fan wire harness from J1 on the Power Supply PCB shown in Figure 10 on page 94.

4. Lift the cooling fan from the slots in the bottom case.

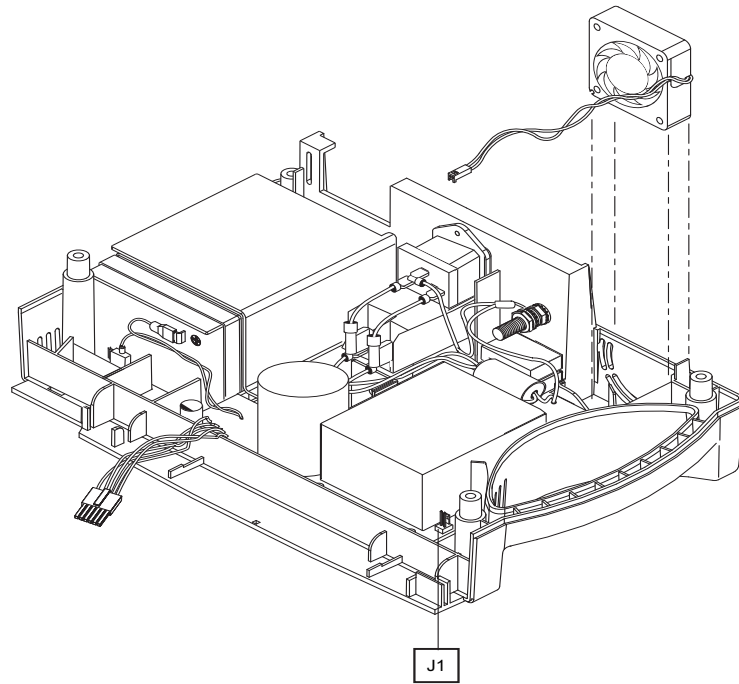

Figure 10: Cooling Fan

Replacing the Cooling Fan

To replace the cooling fan:

1. Connect the cooling fan wire harness to J1 on the Power Supply PCB.
2. Insert the cooling fan into the slots with the padded sides.
3. Follow the steps outlined in *Assembling the Monitor* on page 88.

Display PCB Replacement

Removing the Display PCB



WARNING: The LCD panel contains toxic chemicals. Do not ingest chemicals from a broken LCD panel.

To remove the Display PCB:

1. Turn the monitor off by pressing the ON/STANDBY button.
2. Disconnect the monitor from the AC power source and follow the steps outlined in *Disassembling the Monitor* on page 85.
3. Disconnect the Cold Cathode Fluorescent Light (CCFL) harness from J4 of the Main Board PCB shown in Figure 11 on page 96.
4. Use a small blade screwdriver to remove the clip from either edge of J7, then disconnect the Display PCB ribbon cable from the connector.
5. Separate the adhesive connection of the double-sided tape and lift the Display PCB up to remove it from the top case.

6. Remove and discard the used double-sided tape.

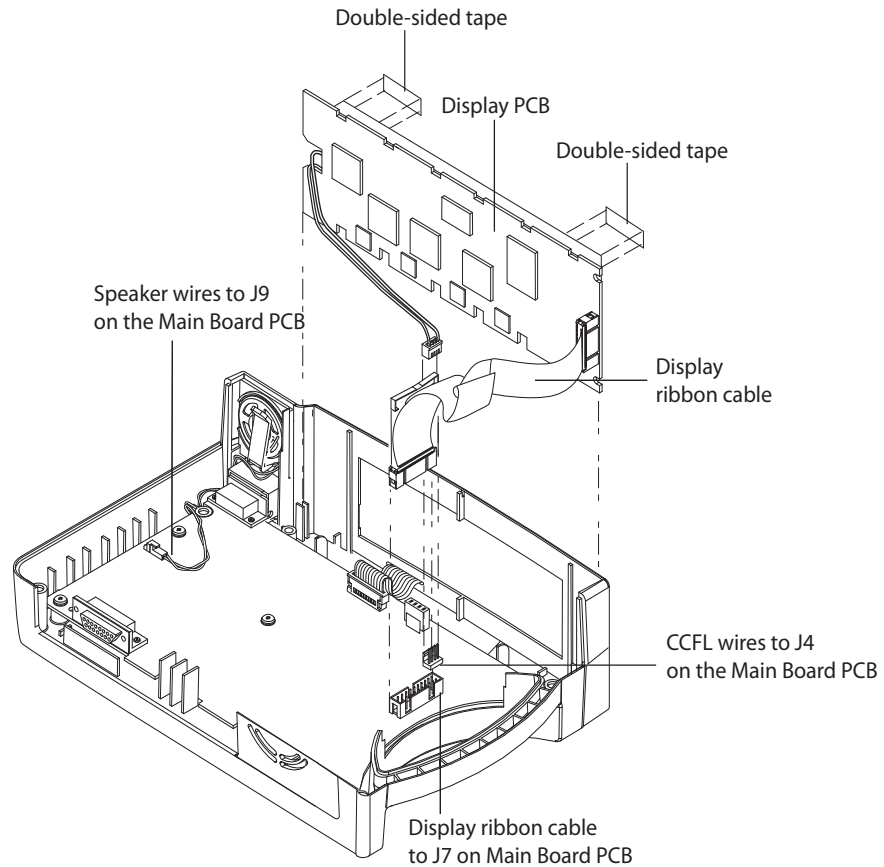

Figure 11: Display PCB

Replacing the Display PCB

To replace the Display PCB:

1. Install new double-sided tape as shown in Figure 11 on page 96.
2. Slide the Display PCB into the grooves in the top case.
3. Ensure the Display PCB is firmly seated in the top case.
4. Apply pressure between the top case and the Display PCB to make good contact with the double-sided tape.

5. Connect the CCFL wire harness with two white wires to J4 on the Main Board PCB.
6. Connect the Display PCB ribbon cable to J7 on the Main Board PCB. Install the clip over the J7 connector.
7. Follow the steps outlined in *Assembling the Monitor* on page 88.

Main Board PCB Replacement

Removing the Main Board PCB

To remove the Main Board PCB:

1. Turn the monitor off by pressing the ON/STANDBY button.
2. Disconnect the monitor from the AC power source and complete the steps outlined in *Disassembling the Monitor* on page 85.
3. Disconnect the CCFL harness (two white wires) from J4 of the Main Board PCB. See Figure 11 on page 96.
4. Use a small blade screwdriver to open the clip from either edge of J7, then disconnect the Display PCB ribbon cable from the connector.
5. Disconnect the keypad ribbon cable from connector J2 on the Main Board PCB. See Figure 11 on page 96.
6. Lift up on the ribbon cable's outer shell until it clicks, then remove the cable from the connector.
7. Disconnect the speaker cable from J9 on the Main Board PCB.
8. Remove the six screws in the Main Board PCB shown in Figure 12.

9. Remove the Main Board PCB from the top case.

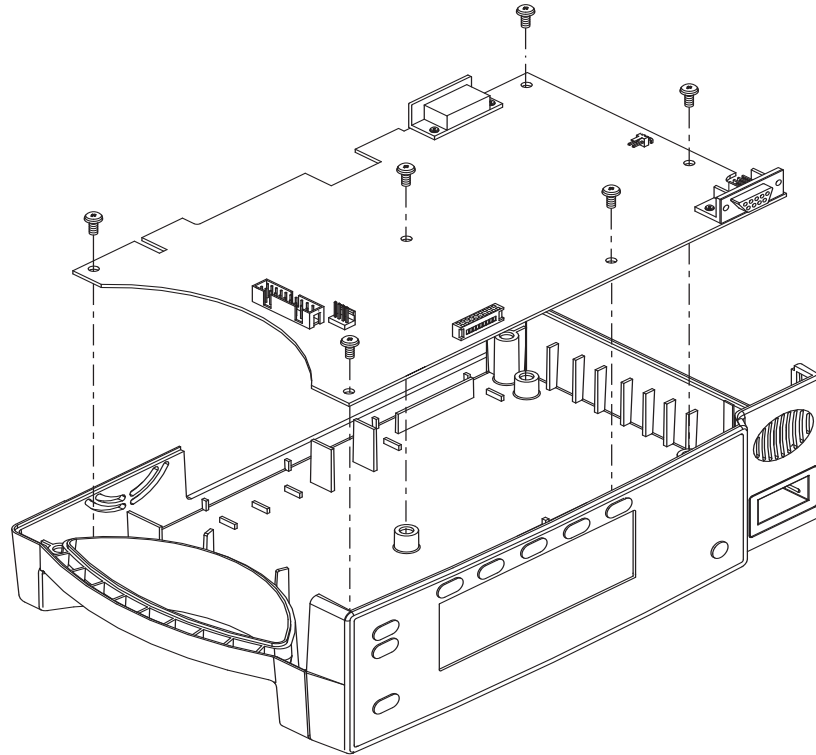

Figure 12: Main Board PCB

Replacing the Main Board PCB



Caution: When installing the Main Board PCB, hand-tighten the six screws (4-in lbs maximum). Overtightening could strip out the screw holes in the top case, rendering it unusable.

To replace the Main Board PCB:

1. Place the Main Board PCB in the top case.
2. Install the six screws in the Main Board PCB.
3. Lift up on the outer shell of J2 Figure 11 on page 96, on the Main Board PCB until it clicks into place.
4. Insert the keypad ribbon cable into J2 on the Main Board PCB.
5. Slide the outer shell of J2 down until it locks in place.

6. Insert the J200 cable into the Main Board PCB until it locks into place.
7. Connect the speaker cable to J9 on the Main Board PCB.
8. Connect the CCFL wire harness with two white wires to J4 on the Main Board PCB.
9. Connect the Display PCB ribbon cable to J7 on the Main Board PCB. Install the clip over the J7 connector.
10. Follow the steps outlined in *Assembling the Monitor* on page 88.

Alarm Speaker Replacement

Removing the Alarm Speaker

To remove the alarm speaker:

1. Turn the monitor off by pressing the ON/STANDBY button.
2. Disconnect the monitor from the AC power source and follow the steps outlined in *Disassembling the Monitor* on page 85.
3. Disconnect the speaker wire harness from J9 on the Main Board PCB shown in *Alarm Speaker* on page 100.

4. Pull the holding clip back from the speaker and lift the speaker out of the top case.

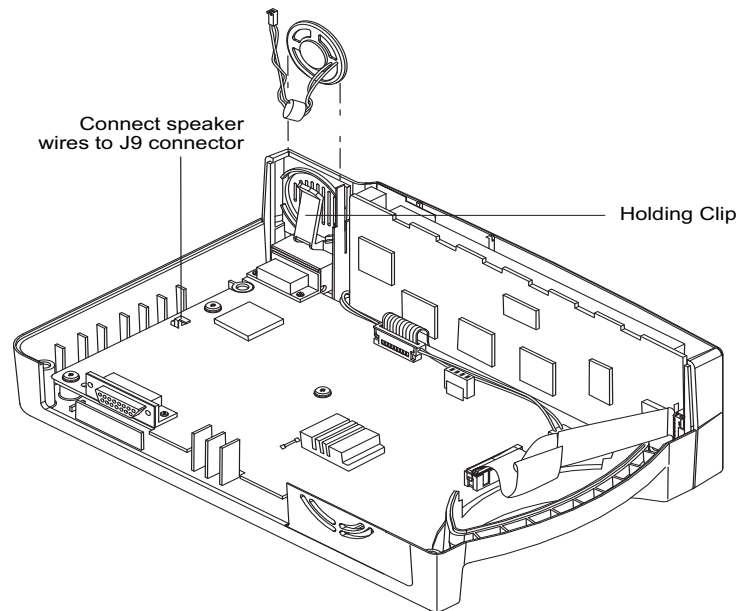

Figure 13: Alarm Speaker

5. Remove the speaker by gently releasing the retaining tab and sliding the speaker assembly from its mounting.



Caution: Avoid using excessive force when pressing the speaker retaining tab.

6. Set aside or discard the original speaker assembly, so it will not be mixed with its replacement.



Note: Please dispose of the original speaker assembly according to your local environmental regulations.

Replacing the Alarm Speaker

To replace the alarm speaker:



Caution: Handle the speaker **ONLY** by the edges of the metal ring to avoid damage.



WARNING: Do not allow other metal objects to come into contact with the speaker; permanent damage may occur.

1. Pull the holding clip back, and insert the speaker into the top case.
2. Connect the speaker wire harness to J9 on the Main Board PCB.
3. Follow the steps outlined in *Assembling the Monitor* on page 88.

Top Case Assembly Replacement

Removing the Top Case Assembly

To remove the top case assembly:

1. Turn the monitor off by pressing the ON/STANDBY button.
2. Disconnect the monitor from the AC power source and follow the steps outlined in *Disassembling the Monitor* on page 85.
3. Follow the steps outlined in *Main Board PCB Replacement* on page 97.

Replacing the Top Case Assembly



Caution: When installing the Main Board PCB, hand-tighten the six screws (4-in lbs. maximum). Overtightening could strip out the screw holes in the top enclosure, rendering it unusable.

Complete the steps outlined in *Main Board PCB Replacement* on page 97.

Spare Parts

Overview

This chapter describes how to order spare parts for the *N-600x* pulse oximeter. Spare parts are shown in Table 15. Item numbers correspond to the callout numbers in Figure 14.

This manual is available on the Internet at:

<http://www.nellcor.com>

Ordering Replacement Parts

Nellcor's Technical Services provides technical assistance information and replacement parts. Contact Nellcor or your local Nellcor representative to obtain replacement parts. Refer to parts by the part names and part numbers.

A listing of the spare parts and accessories for the *N-600x* is on the Internet at:

<http://www.nellcor.com>

Spare Parts List

The figure below shows the *N-600x* expanded view. See the *Spare Parts List* on page 105 for descriptions and part numbers.

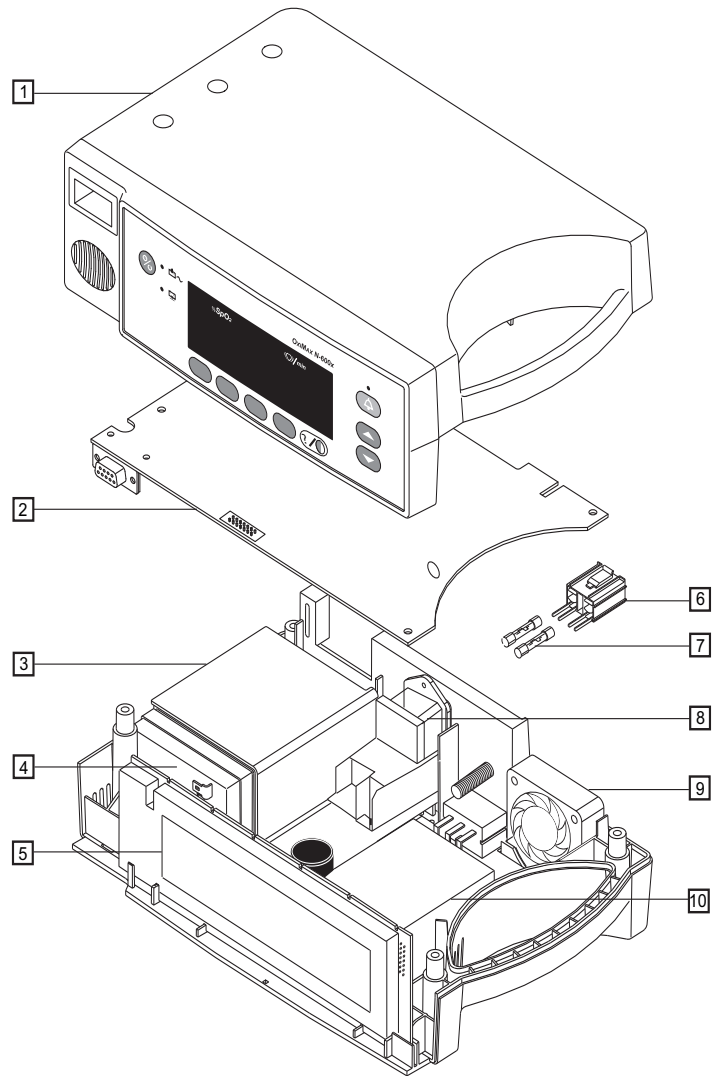

Figure 14: Exploded View

Table 15: Spare Parts List

Item	Description	Part Number
1	Top Enclosure with Membrane Switch	10009087
2	Main Board or Main PCB	SP10014868
3	Battery Bracket	035307
4	Battery	640119
5	Display PCB	SP10006091
6	Fuse Drawer	691500
7	Fuses	691032
8	Power Entry Module	10004406
9	Cooling Fan	10003713
10	Power Supply Board or LPS PCB	SP10011345
...	Alarm Speaker (not shown)	10003280
...	Rubber Feet (not shown)	4-003818-00
...	Power Cord U.S.A. (not shown)	071505
...	Power Cord International (not shown)	901862
...	Power Cord U.K. (not shown)	901863
...	Tilt Stand (not shown)	036702
...	GCX Mounting Kit (not shown)	035434

Packing for Shipment

Overview

This chapter describes how to return your monitor. Contact Nellcor's Technical Services Department or your local Nellcor representative for shipping instructions, including a Returned Goods Authorization (RGA) number. Unless otherwise instructed by Nellcor's Technical Services, it is not necessary to return the *OxIMAX* sensor or any other accessory items with the monitor, unless otherwise instructed by the Nellcor representative. Pack the monitor in its original shipping carton. If the original carton is unavailable, use a suitable carton with appropriate packing material to protect the monitor during shipping. Ensure to return the monitor using a proof of delivery confirmation.

Returning the Monitor



Caution: Pack the monitor carefully. Failure to follow the packing instructions outlined in this section may result in loss or damage not covered by any applicable Nellcor warranty.

If the original shipping carton is not available, use another suitable carton; North American customers may call Nellcor's Technical Services to obtain a shipping carton.

Prior to shipping the monitor, contact your supplier or local Nellcor office (Technical Services Department) for a returned goods authorization number (RGA). Label the shipping carton and any shipping documents with the returned goods authorization number. Return the monitor by any shipper that provides proof of delivery confirmation.

Repacking the Monitor Using the Original Carton

To repack the monitor using the original carton:

If available, use the original carton and packing materials as shown in Figure 15 on page 108. Pack the monitor as follows:

1. Place the monitor and, if necessary, accessory items in original packaging.

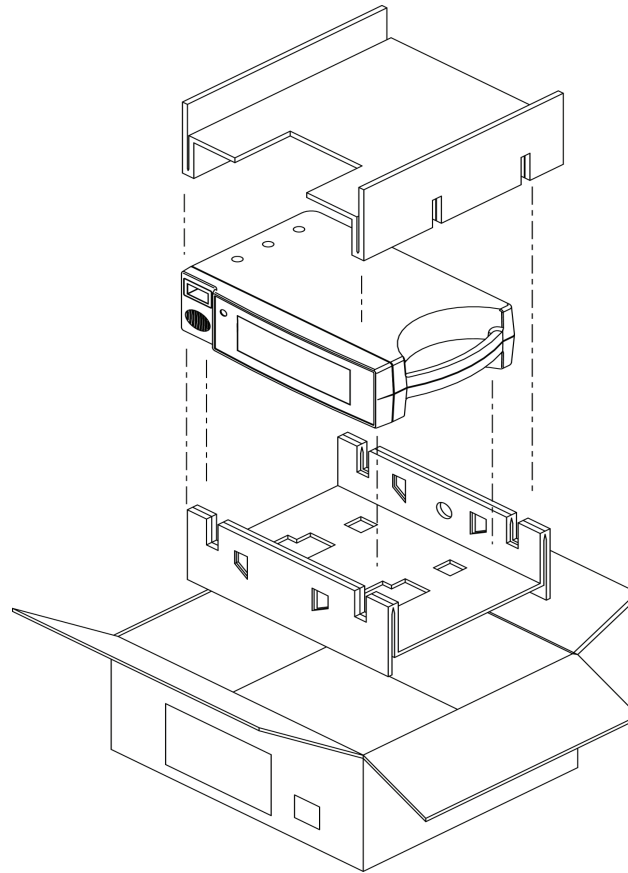

Figure 15: Packing

2. Place in shipping carton and seal the carton with packing tape.
3. Label the carton with a shipping address, return address, and RGA number, if applicable.

Repacking the Monitor Using a Generic Carton

To repack the monitor using a generic carton:

If the original carton is not available, use the following procedure to pack the monitor:

1. Place the monitor in a plastic bag.
2. Locate a corrugated cardboard shipping carton with a bursting strength of at least 200 lbs. per square inch (psi).
3. Fill the bottom of the carton with at least two inches of packing material.
4. Place the bagged unit on the layer of packing material and fill the box completely with packing material.
5. Seal the carton with packing tape.
6. Label the carton with the shipping address, return address, and RGA number, if applicable.

Specifications

Performance

Measurement Range

%SpO ₂	1% to 100%
Pulse Rate	20 to 250 beats per minute (bpm)
Perfusion Range	0.03% to 20%

Accuracy¹

SpO ₂	LoSAT™	
	60% to 80%	70% to 100%
MAX-A, MAX-AL	± 3 digits	± 2 digits
MAX-N ² (Adult and Neonate)	± 3 digits	± 2 digits
Low Perfusion ³		± 2 digits
Pulse Rate		
	20 to 250 bpm	± 3 digits
Low Perfusion ³	20 to 250 bpm	± 3 digits

Accuracy¹

For a complete listing of SpO₂ accuracy across the full line of available Nellcor *OXIMAX* sensors, see the Sensor Accuracy Grid online at: <http://www.nellcor.com>, or contact 1-800-NELLCOR.

¹ Subjects used to validate SpO₂ measurement accuracies were healthy and recruited from the local population. Comprised of both men and women, subjects spanned a range of skin pigmentations and ranged in age from 18-50 years old. Accuracy specifications are based on controlled hypoxia studies with healthy non-smoking adult volunteers over the specified saturation SpO₂ range(s). Pulse oximeter SpO₂ readings were compared to SaO₂ values of drawn blood samples measured by hemoximetry. All accuracies are expressed as ± “X” digits. Pulse oximeter equipment measurements are statistically distributed; about two-thirds of pulse oximeter measurements can be expected to fall in this accuracy (A_{RMS}) range. Because scatter and bias of pulse oximeter SpO₂ and blood SaO₂ comparison commonly increase as the saturation decreases, and accuracy specifications are calculated from data spanning the stated range, different accuracy values may result when described partially overlapping ranges.

² Clinical functionality has been demonstrated on a population of hospitalized neonate patients. The observed SpO₂ accuracy was 2.5% in a study of 42 patients with ages of 1 to 23 days, weight from 750 to 4,100 grams, and 63 observations made spanning a range of 85% to 99% SaO₂ while monitored with the Nellcor *OXIMAX N-595* pulse oximeter.

³ Specification applies to *N-600x* monitor performance. Reading accuracy in the presence of low perfusion (detected IR pulse modulation amplitude 0.03% - 1.5%) was validated using signals supplied by a patient simulator. SpO₂ and pulse rate values were varied across the monitoring range over a range of weak signal conditions and compared to the known true saturation and pulse rate of the input signals.

Display Update Interval

2 seconds

Electrical Requirements

Instrument

Power Requirements	Rated at 100 to 120 volts AC (nominal 120 VAC) or 220 to 240 volts AC (nominal 230 VAC), 30 volt/amps to be compliant with IEC 60601-1 sub-clause 10.2.2
Fuses	Quantity: 2, 0.5 A, 250 volts, slow-blow, IEC (5 x 20 mm)

Battery

The battery provides at least 7 hours of battery life when new and fully-charged with no alarms, no serial data, no analog output, no nurse call output, with backlight on while using a pulse simulator set for 200 bpm, high light and low modulation.

Type	Lead acid
------	-----------

Battery

Voltage	6 Volts DC
Recharge	8 hours with <i>N-600x</i> turned off 12 hours with <i>N-600x</i> turned on
Shelf Life	Four months if the monitor is on a new fully-charged battery. After four months in storage, the <i>N-600x</i> will run for 33% of stated battery life.
Complies With	91/157/EEC

***OxiMAX* Sensors**

Wavelength and Power	Nellcor pulse oximetry sensors contain LEDs that emit red light at a wavelength of approximately 660 nm and infrared light at a wavelength of approximately 900 nm. The total optical output power of the sensor LEDs is less than 15 mW. This information may be useful to clinicians, such as those performing photodynamic therapy.
----------------------	--

Environmental Conditions

Operating

Temperature	5 °C to 40 °C (41 °F to 104 °F)
Altitude	-390 m to 3,012 m (-1,254 ft. to 9,882 ft.)
Atmospheric Pressure	70 kPa to 106 kPa (20.6 in. Hg to 31.3 in. Hg)
Relative Humidity	15% to 95% non-condensing to be compliant with IEC 60601-1, sub-clause 44.5

Transport and Storage (not in shipping container)

Temperature	-20 °C to 60 °C (-4 °F to 140 °F)
Altitude	-390 m to 5,574 m (-1,254 ft. to 18,288 ft.)
Atmospheric Pressure	50 kPa to 106 kPa (14.7 in. Hg to 31.3 in. Hg)
Relative Humidity	15% to 95% non-condensing

Transport and Storage (in shipping container)

Temperature	-20 °C to 70 °C (-4 °F to 158 °F)
Altitude	-390 m to 5,574 m (-1,254 ft. to 18,288 ft.)
Atmospheric Pressure	50 kPa to 106 kPa (14.7 in. Hg to 31.3 in. Hg)
Relative Humidity	15% to 95% non-condensing

OxiMAX Sensor Power Dissipation

Sensor	Dissipation
<i>OxiMAX</i> MAX-N	52.5 mW

OxIMAX Sensor Power Dissipation

Sensor	Dissipation
<i>OxIMAX</i> MAX-I	52.5 mW
<i>OxIMAX</i> MAX-P	52.5 mW
<i>OxIMAX</i> MAX-A	52.5 mW
<i>OxIMAX</i> MAX-AL	52.5 mW
<i>OxIMAX</i> MAX-R	52.5 mW
<i>OxIMAX</i> Durasensor DS-100A	52.5 mW
<i>OxIMAX</i> OxiCliq [®] P	52.5 mW
<i>OxIMAX</i> OxiCliq N	52.5 mW
<i>OxIMAX</i> OxiCliq I	52.5 mW
<i>OxIMAX</i> OxiCliq A	52.5 mW
<i>OxIMAX</i> Dura-Y [®] D-YS	52.5 mW
<i>OxIMAX</i> MAX-FAST	52.5 mW
<i>OxIMAX</i> MAX-SC-A	52.5 mW
<i>OxIMAX</i> MAX-SC-NEO	52.5 mW
<i>OxIMAX</i> MAX-SC-PR	52.5 mW

Physical Characteristics

Weight	5.8 lbs. (2.6 kg)
Dimensions	3.3 in. x 10.4 in. x 6.8 in. (8.4 cm x 26.4 cm x 17.3 cm)

Compliance

Item	Compliant With
Equipment classification	Safety Standards: IEC 60601-1 (same as EN60601-1), CSA 601.1, ISO 9919:2005 UL 60601-1, EN865, EN/IEC 60601-1-2 (second edition)

Item	Compliant With
Type of protection	Class I (on AC power) Internally powered (on battery power)
Degree of protection	Type BF - Applied part
Mode of operation	Continuous
<i>N-600x</i> resistant to liquid ingress	IEC 60601-1, sub-clause 44.6 for class IPX1 Drip-Proof equipment
Degree of Safety in presence of a flammable anaesthetic	UL 60601-1, sub-clause 5.5, Not suitable
Applied sensor label to indicate Type BF applied part	IEC 60601-1 Symbol 2 of Table D of Appendix D
<i>N-600x</i> exterior markings	IEC 60601-1, sub-clause 6.1, 6.3, and 6.4; EN 865, clause 6
Front panel and case labeling	IEC 60878, EN 980, ISO 7000, EN 60417-1, EN 60417-2
<i>N-600x</i> button spacing	ISO 7250
Year of manufacture symbol	EN 980
Operation during physical shock	IEC 60068-2-27 at 100 g
Operation during vibration	IEC 60068-2-6 and IEC 60068-2-34
Electromagnetic Compatibility	IEC 60601-1, sub clause 36, IEC/EN 60601-1-2 (second edition)
Radiated and conducted emissions	EN 55011, Group 1, Class B
Operation with electrical line voltage variations	FDA Reviewer's Guide
Magnetic field susceptibility	RE 101 in MIL-STD-461E

Manufacturer's Declaration



WARNING: The use of accessories, *OxiMAX* sensors, and cables other than those specified may result in increased emission and/or decreased immunity of the *N-600x* pulse oximeter.

Table 16: Electromagnetic Emissions

The *N-600x* is suitable for use in the specified electromagnetic environment. The customer and/or user of the *N-600x* should assure that it is used in an electromagnetic environment as described below:

Emissions Test	Compliance	Electromagnetic Environment Guidance
RF emissions CISPR 11	Group 1	The <i>N-600x</i> must emit electromagnetic energy in order to perform its intended function. Nearby electronic equipment may be affected.
RF emissions CISPR 11	Class B	The <i>N-600x</i> is suitable for use in all establishments.
Harmonic emissions IEC 61000-3-2	Complies	
Voltage fluctuations/ flicker emission IEC 61000-3-3	Complies	

Table 17: Electromagnetic Immunity

The *N-600x* is suitable for use in the specified electromagnetic environment. The customer and/or user of the *N-600x* should assure that it is used in an electromagnetic environment as described below.

Immunity Test	IEC 60601-1-2 Test Level	Compliance Level	Electromagnetic Environment Guidance
Electrostatic discharge (ESD) IEC 61000-4-2	± 6 kV contact ± 8 kV air	± 6 kV contact ± 8 kV air	Floor should be wood, concrete, or ceramic tile. If floors are covered with synthetic material, the relative humidity should be at least 30 %.

Note: U_T is the AC mains voltage prior to application of the test level.

Table 17: Electromagnetic Immunity

The *N-600x* is suitable for use in the specified electromagnetic environment. The customer and/or user of the *N-600x* should assure that it is used in an electromagnetic environment as described below.

Immunity Test	IEC 60601-1-2 Test Level	Compliance Level	Electromagnetic Environment Guidance
Electric fast transient/burst IEC 61000-4-4	± 2 kV for power supply lines ± 1 kV for input/output lines	± 2 kV for power supply lines ± 1 kV for input/output lines	Mains power quality should be that of a typical commercial and/or hospital environment
Surge IEC 61000-4-5	± 1 kV differential mode ± 2 kV common mode	± 1 kV differential mode ± 2 kV common mode	Mains power quality should be that of a typical commercial and/or hospital environment
Voltage dips, short interruptions and voltage variations on power supply IEC 61000-4-11	$<5\% U_T$ ($>95\%$ dip in U_T) for 0.5 cycle $40\% U_T$ (60% dip in U_T) for 5 cycles $70\% U_T$ (30% dip in U_T) for 25 cycles $<5\% U_T$ (95% dip in U_T) for 5 seconds	$<5\% U_T$ ($>95\%$ dip in U_T) for 0.5 cycle $40\% U_T$ (60% dip in U_T) for 5 cycles $70\% U_T$ (30% dip in U_T) for 25 cycles $<5\% U_T$ (95% dip in U_T) for 5 seconds	Mains power quality should be that of a typical commercial and/or hospital environment. If the user of the <i>N-600x</i> requires continued operation during power mains interruption, it is recommended that the <i>N-600x</i> be powered from an uninterruptible power supply or battery.

Note: U_T is the AC mains voltage prior to application of the test level.

Table 17: Electromagnetic Immunity

The *N-600x* is suitable for use in the specified electromagnetic environment. The customer and/or user of the *N-600x* should assure that it is used in an electromagnetic environment as described below.

Immunity Test	IEC 60601-1-2 Test Level	Compliance Level	Electromagnetic Environment Guidance
Power frequency (50/60 Hz) magnetic field IEC 61000-4-8	3 A/m	3 A/m	If image distortion occurs, it may be necessary to position the <i>N-600x</i> further from the sources of power frequency magnetic fields or to install magnetic shielding. The power frequency magnetic field should be measured in the intended installation location to assure that it is sufficiently low.

Note: U_T is the AC mains voltage prior to application of the test level.

Table 18: Electromagnetic Immunity, RF Portable Equipment

The *N-600x* is suitable for use in the specified electromagnetic environment. The customer and/or user of the *N-600x* should assure that it is used in an electromagnetic environment as described below:

Immunity Test	IEC 60601-1-2 Test Level	Compliance Level	Electromagnetic Environment Guidance
Portable and mobile RF communications equipment should be used no closer to any part of the <i>N-600x</i> , including cables, than the recommended separation distance calculated from the equation appropriate for the frequency of the transmitter.			
		Recommended Separation Distance	

Note: Field strengths from fixed transmitters, such as base stations for radio (cellular/cordless) telephones and land mobile radios, amateur radio, AM and FM radio broadcast, and TV broadcast cannot be predicted theoretically with survey accuracy. To assess the electromagnetic environment due to fixed RF transmitters, an electromagnetic site survey should be considered. If the measured field strength in the location in which the *N-600x* is used exceeds the applicable RF compliance level above, the *N-600x* should be observed to verify normal operation. If abnormal performance is observed, additional measures may be necessary, such as reorienting or relocating the *N-600x*.

Note: These guidelines may not apply in all situations. Electromagnetic propagation is affected by absorption and reflection from structures, objects, and people.

Interference may occur in the vicinity of equipment marked with the following symbol:



Table 18: Electromagnetic Immunity, RF Portable Equipment

The *N-600x* is suitable for use in the specified electromagnetic environment. The customer and/or user of the *N-600x* should assure that it is used in an electromagnetic environment as described below:

Immunity Test	IEC 60601-1-2 Test Level	Compliance Level	Electromagnetic Environment Guidance
Radiated RF IEC 61000-4-3	3 V/m 80 MHz 800 MHz	3 V/m	$distance = 1.2 \sqrt{Power}$ 80 MHz to 800 MHz
	3 V/m 800 MHz 2.5 GHz	3 V/m	$distance = 2.3 \sqrt{Power}$ 800 MHz to 2.5 GHz
Conducted RF IEC 61000-4-6	3 Vrms 150 kHz 80 MHz	3 Vrms	$distance = 1.2 \sqrt{Power}$ 150 kHz to 80 MHz

Note: Field strengths from fixed transmitters, such as base stations for radio (cellular/cordless) telephones and land mobile radios, amateur radio, AM and FM radio broadcast, and TV broadcast cannot be predicted theoretically with survey accuracy. To assess the electromagnetic environment due to fixed RF transmitters, an electromagnetic site survey should be considered. If the measured field strength in the location in which the *N-600x* is used exceeds the applicable RF compliance level above, the *N-600x* should be observed to verify normal operation. If abnormal performance is observed, additional measures may be necessary, such as reorienting or relocating the *N-600x*.

Note: These guidelines may not apply in all situations. Electromagnetic propagation is affected by absorption and reflection from structures, objects, and people.

Interference may occur in the vicinity of equipment marked with the following symbol:



Table 19: Recommended Separation Distances

Recommended Separation Distances between Portable and Mobile RF Communications Equipment and the *N-600x* (IEC 60601-1-2)

Frequency of Transmitter	150 kHz to 80 MHz	80 MHz to 800 MHz	800 MHz to 2.5 GHz
Equation	$d = 1.2 \sqrt{P}$	$d = 1.2 \sqrt{P}$	$d = 2.3 \sqrt{P}$
Rated Maximum Output Power of Transmitter in Watts	Separation Distance in Meters	Separation Distance in Meters	Separation Distance in Meters
0.01	0.12	0.12	0.23
0.1	0.38	0.38	0.73
1	1.2	1.2	2.3
10	3.8	3.8	7.3
100	12	12	23

For transmitters rated at a maximum output power not listed above, the separation distance can be estimated using the equation in the corresponding column, where P is the maximum output [power rating of the transmitter in watts (W)] according to the transmitter manufacturer.

Note: These guidelines may not apply in all situations. Electromagnetic propagation is affected by absorption and reflection from structures, objects, and people.

Table 20: Cables

Cables and Sensors	Maximum Length	Complies With
DOC-10 pulse oximetry cable	10.0 ft. (3 m)	<ul style="list-style-type: none"> RF emissions, CISPR 11, Class B/Group 1 Harmonic emissions, IEC 61000-3-2 Voltage fluctuations/flicker emission, IEC 61000-3-3 Electrostatic discharge (ESD), IEC 61000-4-2 Electric fast transient/burst, IEC 61000-4-4 Surge, IEC 61000-4-5 Conducted RF IEC 61000-4-6 Radiated RF, IEC 61000-4-3 ISO 9919
Software download cable, RS-232 serial, 15 to 9 pin "D"	10.0 ft. (3 m)	
Non-terminated cable, RS-232/ Analog, 15 pin "D"	10.0 ft. (3 m)	
Oxinet hardwire cable	10.0 ft. (3 m)	
Printer cable, RS-232, 15 to 9 pin "D"	10.0 ft. (3 m)	
<u>Philips</u> interface cable	3.3 ft. (1 m)	
GE Marquette interface cable	3.3 ft. (1 m)	
Datex-Ohmeda interface cable	3.3 ft. (1 m)	
Oxinet [®] II Data Cable	10.0 ft. (3 m)	
<i>OxIMAX</i> sensors:		
MAX-A	1.5 ft. (0.5 m)	<ul style="list-style-type: none"> RF emissions, CISPR 11, Class B/Group 1 Harmonic emissions, IEC 61000-3-2 Voltage fluctuations/flicker emission, IEC 61000-3-3 Electrostatic discharge (ESD), IEC 61000-4-2 Electric fast transient/burst, IEC 61000-4-4 Surge, IEC 61000-4-5 Conducted RF IEC 61000-4-6 Radiated RF, IEC 61000-4-3 ISO 9919
MAX-AL	3.0 ft. (0.9 m)	
MAX-I	1.5 ft. (0.5 m)	
MAX-N	1.5 ft. (0.5 m)	
MAX-P	1.5 ft. (0.5 m)	
MAX-R	1.5 ft. (0.5 m)	
<i>OxIMAX Oxiband[®]</i> sensors:	3.0 ft. (0.9 m)	
OXI-A/N		
OXI-P/I		

Table 20: Cables

Cables and Sensors	Maximum Length	Complies With
<i>OxIMAX Durasensor</i> sensor DS-100A	3.0 ft. (0.9 m)	<ul style="list-style-type: none"> • RF emissions, CISPR 11, Class B/Group 1 • Harmonic emissions, IEC 61000-3-2 • Voltage fluctuations/flicker emission, IEC 61000-3-3 • Electrostatic discharge (ESD), IEC 61000-4-2 • Electric fast transient/burst, IEC 61000-4-4 • Surge, IEC 61000-4-5 ISO 9919 • Conducted RF IEC 61000-4-6 • Radiated RF, IEC 61000-4-3
<i>OxIMAX OxiCliq</i> sensors: P N I A	OC-3 cable 3.0 ft. (0.9 m)	<ul style="list-style-type: none"> • RF emissions, CISPR 11, Class B/Group 1 • Harmonic emissions, IEC 61000-3-2 ISO 9919 • Voltage fluctuations/flicker emission, IEC 61000-3-3
<i>OxIMAX Dura-Y</i> sensors: D-YS D-YSE D-YSPD	4.0 ft. (1.2 m)	<ul style="list-style-type: none"> • Electrostatic discharge (ESD), IEC 61000-4-2 • Electric fast transient/burst, IEC 61000-4-4 • Surge, IEC 61000-4-5 • Conducted RF IEC 61000-4-6 • Radiated RF, IEC 61000-4-3

Safety Tests

Ground Integrity

100 milliohms or less

Earth Leakage Current

The following table displays the maximum earth leakage current allowed:

AC Polarity	Line Cord	Neutral Cord	EN/IEC 60601-1	UL 60601-1
Normal	Closed	Closed	500 μ A	300 μ A
Reversed	Closed	Closed	500 μ A	300 μ A
Normal	Open	Closed	1000 μ A (under fault condition)	500 μ A
Normal	Closed	Open	1000 μ A (under fault condition)	500 μ A

Enclosure Leakage Current

The following table displays the maximum enclosure leakage current limits allowed:

AC Line Polarity	Neutral Line Cord	Power Line Ground Cable	IEC 60601-1	UL 60601
Normal	Closed	Closed	100 μ A	300 μ A
Normal	Closed	Open	500 μ A	300 μ A
Normal	Open	Closed	100 μ A	300 μ A *
Reversed	Closed	Closed	500 μ A	300 μ A
Reversed	Open	Closed	500 μ A	300 μ A *
Reversed	Closed	Open	500 μ A	300 μ A

Patient Applied Risk Current

The following table displays the maximum patient applied risk current for a BF type applied part.

AC Line Polarity	Neutral Line	Power Line Ground Cable	IEC 60601-1 UL 60601-1
Normal	Closed	Closed	100 μ A
Normal	Open	Closed	500 μ A
Normal	Closed	Open	500 μ A
Reversed	Closed	Closed	100 μ A
Reversed	Open	Closed	500 μ A
Reversed	Closed	Open	500 μ A

Patient Isolation Risk Current

The following table displays the maximum patient isolation risk current for a BF type applied part.

AC Line Polarity	Neutral Line	Power Line Ground Cable	IEC 60601-1 UL 2601-1
Normal	Closed	Closed	5 mA
Reversed	Closed	Closed	5 mA

Data Port Interface Protocol

Overview

When connected to the data port on the back of the *N-600x*, printouts can be obtained or patient data can be communicated to a Nellcor Oxinet II monitoring system, Nellcor Oxinet III monitoring system, Nellcor Intouch Remote Oximetry Notification System or personal computer. Analog signals representing %SpO₂, pulse rate, and pulse amplitude are also provided by the data port. A nurse call function is also available from the data port.

The *N-600x* provides a bedside monitor communication for interfacing with Philips, GE Marquette, and Datex-Ohmeda AS/3 monitors.

Configuring the Data Port

Items pertaining to the data port can be adjusted by following the softkey map below. For a complete description of the softkeys, see the *OxIMAX N-600x Operator's Manual*.

```
SETUP
-  NEXT
-  -  LANG
-  -  -  ENGLISH
-  -  -  DANSK
-  -  -  FRANCAIS
-  -  -  DEUTSCH
-  -  -  ITALIANO
-  -  -  ESPAÑOL
-  -  -  NEDERLANDS
-  -  -  NORSK
-  -  -  PORTUG
-  -  -  SUOMI
-  -  -  SVERIGE
-  -  -  BACK (back to Setup menu)
```

- - **NEXT**
- - - **COMM**
- - - - **SELECT**
 - BAUD**
 - 2400**
 - 9600**
 - 19200**
 - PROTOCOL**
 - ASCII**
 - OXINET**
 - CLINICAL**
 - GRAPH**
 - PHILIPS** (*Philips monitors*)
 - MARQ** (*GE Marquette monitors*)
 - DATEX** (*Datex-Ohmeda AS/3 monitor*)
- - - - **BACK** (*back to Setup menu*)
- - - - **EXIT** (*back to Main menu*)
- - - **NCALL** (*Nurse Call*)
- - - - **NORM +**
- - - - **NORM -**
- - - - **BACK** (*back to Setup menu*)
- - - - **EXIT** (*back to Main menu*)
- - - **NEXT**
- - - - **ANALOG**
 - **0 VOLT**
 - **1 VOLT**
 - **STEP**
- - - - **BACK** (*back to Setup menu*)
- - - - **EXIT** (*back to Main menu*)
- - - **BACK** (*back to Setup menu*)
- - **BACK** (*back to Setup menu*)
- **EXIT** (*back to Main menu*)

Communication Baud Rate

The baud rate may need to be changed to match the abilities of the attached equipment. Perform the following procedure to change the baud rate to 2400, 9600, or 19200.



Note: When setting the communication protocol to Philips, GE Marquette, or Datex the communication baud rate is automatically set.

To adjust the communication baud rate:

1. Turn on the monitor by pressing the ON/STANDBY button.
2. Press the SETUP softkey.
3. Press the NEXT softkey twice.

4. Press the COMM softkey.

SERIAL PORT SETUP		%SP02
BAUD	9600	100.
PROTOCOL	ASCII	BPM 100.
SELECT	BACK	EXIT

5. Use the ADJUST UP and ADJUST DOWN buttons to select the desired baud rate.
6. Press the EXIT softkey to set the baud rate. The baud rate setting will be in effect until the monitor is powered off.



Note: The baud rate setup for the monitor may be saved as institutional default settings. See *WARNING: Audible alarms should not be silenced if patient safety could be compromised.* on page 60. Use care when performing this procedure since all settings will be saved as institutional default settings.

Communication Protocol

The COMM softkey is used to select from eight communication protocols supported by the data port. The selections are:

- ASCII used for printouts
- OXINET to enable communication with OXINET II
- CLINICAL intended for Nellcor use only
- GRAPH for graphic printouts
- PHILIPS interfaces the *N-600x* with a Philips monitor
- MARQ interfaces the *N-600x* with a GE Marquette monitor
- DATEX interfaces the *N-600x* with a Datex-Ohmeda AS/3 monitor



Note: Selecting Philips, GE Marquette, or Datex-Ohmeda AS/3 automatically sets the baud rate to the rate applicable for that protocol.

To change the communication protocol:

1. Turn on the monitor by pressing the ON/STANDBY button.
2. Press the SETUP softkey.
3. Press the NEXT softkey twice.
4. Press the COMM softkey.
5. Press the SELECT softkey.

SERIAL PORT SETUP		%SP02	---
BAUD	9600	BPM	---
PROTOCOL	<input type="text" value="ASCII"/>		
SELECT		EXIT	

6. Use the ADJUST UP and ADJUST DOWN buttons to select the desired protocol.
7. Press the EXIT softkey set the protocol. The protocol setting is in effect until the monitor is powered off.



Note: The protocol setup for the monitor may be saved as institutional default settings. See *WARNING: Audible alarms should not be silenced if patient safety could be compromised.* on page 60. Use care when performing this procedure since all settings will be saved as institutional default settings.

Language Selection

Eleven (11) languages can be viewed on the screen and sent to the printer. The languages are:

ENGLISH
DANSK (Danish)
DEUTSCH (German)
ESPAÑOL (Spanish)
FRANCAIS (French)
ITALIANO (Italian)
NEDERLANDS (Dutch)
NORSK (Norwegian)
PORTUG (Portuguese)
SUOMI (Finnish)
SVERIGE (Swedish)

To change the displayed language setting:

1. Turn on the monitor by pressing the ON/STANDBY button.
2. Press the SETUP softkey.
3. Press the NEXT softkey.
4. Press the LANG softkey.

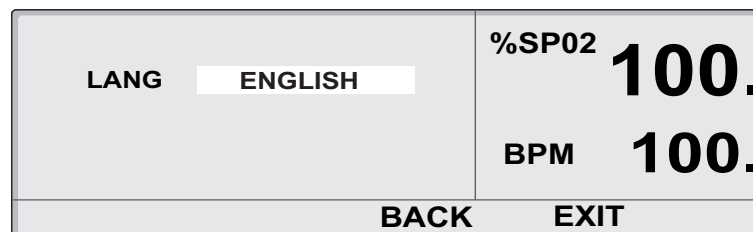

5. Use the ADJUST UP and ADJUST DOWN buttons to select the desired language.
6. Press the BACK softkey to save the language setting.

Nurse Call Setup

The voltage polarity for the Nurse Call, available at pins 11 and 5, can be selected through the softkeys. NORM + sets the voltage to +5 VDC to +12 VDC and NORM - sets the voltage to -5 VDC to -12 VDC when there is no audible alarm. When an audible alarm occurs, these voltages switch polarity. This signal is available only if the instrument is operating on AC power. For more information, see *Nurse Call* on page 145.

To adjust the voltage polarity setting:

1. Turn on the monitor by pressing the ON/STANDBY button.
2. Press the SETUP softkey.
3. Press the NEXT softkey twice.
4. Press the NCALL softkey.

			%SP02	---
			BPM	---
NORM +	NORM -	BACK	EXIT	

5. Press the NORM+ (+5 to +12 VDC) or NORM- (-5 to -12 VDC) softkey as required for your nurse call system.

Analog Calibration Setup

Analog calibration signals are provided to adjust a recorder to the output of the instrument. Selectable calibration signals are +1.0 VDC, 0.0 VDC, and Step. For more information on the analog signals see *Analog Output* on page 146.

To adjust the analog calibration signal:

1. Turn on the monitor by pressing the ON/STANDBY button.
2. Press the SETUP softkey.
3. Press the NEXT softkey three (3) consecutive times.
4. Press the ANALOG softkey.

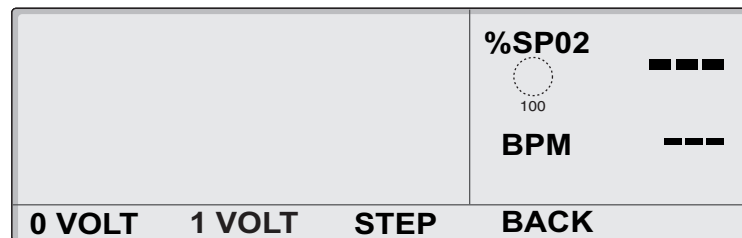

5. Press the 0 VOLT, 1 VOLT, or STEP softkey as required.
6. Press the BACK softkey.

Philips Communications

The *N-600x* sends %SpO₂, pulse rate, and alarm status data to the Philips monitor. The Philips monitor requires a Philips VueLink™ Aux Plus B interface module (A05 option) to interface with the *N-600x* pulse oximeter.

The RS-232 hardware interface cable has a DB-15 connector for the *N-600x* and the applicable connector for the Philips monitor. The Nellcor cable part number 902256 is recommended for this interface.

A blank screen on the Philips monitor indicates corrupt data. The Philips monitor detects corrupt data in less than 100 milliseconds. When the *N-600x* is in the Philips mode of operation, the interface baud rate is automatically set to 19,200 bits per second (bps).

GE Marquette Communications

The monitor sends %SpO₂, pulse rate, and alarm status data to the GE Marquette monitor. The Marquette monitor requires an Octanet™ interface module to interface with the *N-600x* pulse oximeter. The interface module comes with an interface cable, GE Marquette part number 417961-033, that connects to the Nellcor interface cable. The RS-232 hardware interface cable has a DB-15 connector for the monitor and the applicable connector for the Marquette Octanet™ interface module cable. Nellcor cable part number 902254 is recommended for this interface. Corrupt data is indicated by a Communications Error displayed on the GE Marquette monitor. When the *N-600x* is in the GE Marquette mode of operation the interface baud rate is automatically set to 9,600 bits per second. The GE Marquette monitor only sounds audible alarms for equipment interfaced through the Octanet™ interface module. Silencing the monitor audible alarm has no effect on the GE Marquette monitor sounding an alarm.



Note: The parameters setup for the GE Marquette bedside monitor interface may be saved as institutional default settings. See *WARNING: Audible alarms should not be silenced if patient safety could be compromised.* on page 60. Use care when performing this procedure since all settings will be saved as institutional default settings.

Datex-Ohmeda AS/3 Communications

The Datex-Ohmeda AS/3 monitor must be configured for communications with the Nellcor N-200 monitor in order to communicate with the *N-600x* monitor. Refer to the *AS/3 Operator's Manual* for instructions on configuring the AS/3 monitor. The *N-600x* sends SpO₂, pulse rate, and alarm status data to the Datex AS3 monitor. The RS-232 hardwire interface cable has a DB-15 connector for the monitor and the applicable connector for the Datex monitor. Nellcor cable part number 902255 is recommended for this interface. Corrupt data is indicated by a Communications Error displayed on the Datex monitor. When the monitor is in the Datex mode of operation the interface baud rate is automatically set to 2,400 bits per second.



WARNING: Do not silence or decrease the volume of the *N-600x* audible alarm if patient safety could be compromised.

The Datex-Ohmeda AS/3 monitor does not indicate audible or visual alarms for equipment interfaced. The monitor must be able to sound an audible alarm in order to maintain patient safety.



Note: The parameters setup for the Datex-Ohmeda bedside monitor interface may be saved as institutional default settings. See *WARNING: Audible alarms should not be silenced if patient safety could be compromised.* on page 60. Use care when performing this procedure since all settings are saved as institutional default settings.

Connecting to the Data Port

Data is transmitted in the RS-232 format (pins 2, 3, and 5) or RS-422 (pins 1, 4, 9, and 12). RS-232 data can be transmitted a maximum of 25 feet, RS-422 data up to 4000 feet. The pin outs for the data port are illustrated in Figure 16.

Table 21: Data Port Pin Outs

Pin	Signal
1	RXD+ (RS-422 positive input)
2	RXD_232 (RS-232 input)
3	TXD_232 (RS-232 output)
4	TXD+ (RS-422 positive output)
5	Signal Ground (isolated from earth ground)
6	AN_SpO2 (analog saturation output)
7	Normally Open (N.O.), Dry Contacts, for Nurse Call (N.O. with no audible alarm)
8	Normally Closed (N.C.), Dry Contacts, for Nurse Call (N.C. with no audible alarm)
9	RXD- (RS-422 negative output)
10	Signal Ground (isolated from earth ground)
11	Nurse Call (RS-232 level output [-5 to -12 VDC with no audible alarm] [+5 to +12 VDC with audible alarm])
12	TXD- (RS-422 negative output)
13	AN_Pulse (analog pulse rate)
14	AN_Pleth (analog Pleth waveform output)
15	Nurse Call Common for Dry Contacts



Note: When the instrument is turned off, the contact at pin 7 is closed and pin 8 is open.

The pin layout is illustrated in Figure 16 is viewed from the back of the monitor. An AMP connector is used to connect to the data port. Use AMP connector (AMP P/N 747538-1), ferrule (AMP P/N 1-747579-2), and compatible pins (AMP P/N 66570-2).

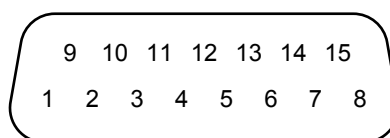

Figure 16: Data Port Pin Layout

When building an RS-422 cable, a resistor (120 ohms, 1/2 watt, 5%) must be added between pins 1 and 9 of the cable. The end of the cable with the resistor added must be plugged into the monitor. This resistor is not necessary for RS-232 cables.

The data cable must be shielded (example: Belden P/N 9616). Connectors at both ends of the data cable must have the shield terminated to the full 360 degrees of the connector's metal shell. If rough handling or sharp bends in the cable is anticipated, use a braided shield.

Communicating with a Computer

Data can be sent from the monitor to a computer by using a data cable with a Null modem connector installed between the instrument and the computer. Select the ASCII Comm protocol (see *Communication Protocol* on page 129). Data sent to the computer is serial, 8 data bits, no parity, 1 stop bit XON/XOFF flow control and is space delineated. When the connection is made, real-time data is sent to the computer. A new line of data is sent every 2 seconds. See *Real-Time Printout* on page 139.

Holding the Ctrl-key on the computer keyboard and pressing “C” twice accesses an interactive mode. When the interactive mode has been activated, real-time serial output is stopped and serial input is accepted. Printouts can be requested or the date and time can be adjusted through the computer.

The computer monitor displays five options:

1. Dump Instrument Info
2. Set Date and Time
3. Dump Trend
4. Dump Error Log
5. Exit Interactive Mode

Dump Instrument Info (Option 1)

Option 1 allows the Instrument Info to be printed, displayed on the computer screen and intended for Nellcor's personnel. Instrument Info is a single line of data, which includes software version, CRC number, and total operating time.

Set Date and Time (Option 2)

When the instrument is shipped from the factory, the date and time are set to the local time zone during manufacturing. If the battery has been removed or disconnected, the time clock will not reflect the actual date and time. After battery power has been restored, reset the time clock.

Option 2 is used to change the date and time via the computer. The format for date and time is DD-MM-YY HH:MM:SS. Move the cursor under the value to be changed and enter the new value.

Dump Trend (Option 3)

Option 3 outputs current trend information. Up to 48 hours of trend information can be viewed. Information presented includes:

- Instrument Type
- Software Revision Level
- Printout Type
- Alarm Limits
- Date And Time
- %SpO₂
- Pulse Rate
- Pulse Amplitude

Dump Error Log (Option 4)

Option 4 outputs a list of all of the in memory. The information that can be viewed includes instrument type, software revision level, printout type, time of printout, operating time of the recorded error, error number, task number, address, and count. This option is intended for Nellcor's field service personnel.

Exit Interactive Mode (Option 5)

Option 5 closes the interactive mode and returns the data port to normal operation.

Using Data on the Computer

Data displayed on the computer screen can be captured for use in a word processing spreadsheet.

To access data using a computer:

1. Open a terminal program, such as Hyper Terminal.
2. Verify the communications format is compatible with the data port of the monitor. If the communications format is compatible, real-time data begins to be displayed on the computer.
3. Capture the text to a file.
4. Press Ctrl-C to halt the data flow.
5. Import the data file into the spreadsheet. The data can now be manipulated by the commands of the spreadsheet. Some formatting of the data may be necessary.

Real-Time Printout

When a real-time display or printout is being transmitted to a printer or computer, a new line of data is printed every two seconds. Every 25th line is a column heading line. A column heading line is also printed when a value in the column heading line is changed. A real-time printout is shown in Figure 17.



Note: If the data output stops transmitting, turn the power off and back on again, or, if the monitor is connected to a computer, send an XON (Ctrl-q) to resume transmission.

```

N-600x VERSION 4.0.0.0 CRC: XXXX SpO2 Limit: 85-100% PR Limit: 40-170BPM
      ADULT  0SAT-S      SPO2 RESP MODE: NORMAL
TIME                %SpO2  BPM  PA      Status
01-JAN-06 14:00:05 100   120  50
01-JAN-06 14:00:07 100   124  50
01-JAN-06 14:00:09 100   190* 52      PH
01-JAN-06 14:00:11 100   190* 50      PH
01-JAN-06 14:00:13 100   190* 51      PH
01-JAN-06 14:00:15 100   190* 50      PH
01-JAN-06 14:00:17 100   190* 50      PH
01-JAN-06 14:00:19 100   190* 51      PH
01-JAN-06 14:00:21 100   190* 53      PH  LB
01-JAN-06 14:00:23 100   190* 50      PH  LB
01-JAN-06 14:00:25 100   090* 50      PH  LB
01-JAN-06 14:00:27 ---    ---  ---      SD      LB
01-JAN-06 14:00:29 ---    ---  ---      SD      LB
01-JAN-06 14:00:31 ---    ---  ---      SD
01-JAN-06 14:00:33 ---    ---  ---      SD
01-JAN-06 14:00:35 ---    ---  ---      SD
01-JAN-06 14:00:37 ---    ---  ---      SD
01-JAN-06 14:00:39 ---    ---  ---      SD
01-JAN-06 14:00:41 ---    ---  ---      SD
01-JAN-06 14:00:43 ---    ---  ---      SD
01-JAN-06 14:00:45 ---    ---  ---      SD
01-JAN-06 14:00:47 ---    ---  ---      SD
01-JAN-06 14:00:49 ---    ---  ---      SD
N-600x VERSION 4.0.0.0 CRC: XXXX SpO2 Limit: 85-100% PR Limit: 40-170BPM
      ADULT  0SAT-S      SPO2 RESP MODE: NORMAL
TIME                %SpO2  BPM  PA      Status
01-JAN-06 14:00:51 ---    ---  ---      SD
N-600x VERSION 4.0.0.0 CRC: XXXX SpO2 Limit: 80-100% PR Limit: 40-170BPM
      ADULT  0SAT-S      SPO2 RESP MODE: NORMAL
TIME                %SpO2  BPM  PA      Status
01-JAN-06 14:00:53 79*   59   50      SL  PL  LB
01-JAN-06 14:00:55 79*   59   50      PS SL  PL  LB
    
```

Figure 17: Real-Time Printout

Column Heading

The first two lines of the chart are the column headings shown below. Every 25th line a column heading is printed. A column heading is also printed when a value of the column heading is changed. There are three column headings shown in Figure 17. The third column heading was printed since the %SpO₂ limits changed from 85-100% to 80-100%.

N-600x	VERSION X.X.X.X	CRC: XXXX	SpO2 Limit: 70-100%	PR Limit: 60-160BPM
	ADULT	OSAT-S	SPO2 RESP MODE: NORMAL	
TIME	%SpO ₂	BPM	PA	Status

Data Source

N-600x	VERSION X.X.X.X	CRC: XXXX	SpO2 Limit: 70-100%	PR Limit: 60-160BPM
	ADULT	OSAT-S	SPO2 RESP MODE: NORMAL	
TIME	%SpO ₂	BPM	PA	Status

Data in the highlighted box above represents the source of the printout or display, in this case the monitor.

Software Revision Level

N-600x	VERSION X.X.X.X	CRC: XXXX	SpO2 Limit: 70-100%	PR Limit: 60-160BPM
	ADULT	OSAT-S	SPO2 RESP MODE: NORMAL	
TIME	%SpO ₂	BPM	PA	Status

The next data field tells the user the software level (Version X.X.X.X) and a software verification number (CRC XXXX). Neither of these numbers should change during normal operation. The numbers change if the monitor is serviced and receives a software upgrade.

Alarm Limits

N-600x	VERSION X.X.X.X	CRC: XXXX	SpO2 Limit: 70-100%	PR Limit: 60-160BPM
	ADULT	OSAT-S	SPO2 RESP MODE: NORMAL	
TIME	%SpO ₂	BPM	PA	Status

The last data field in the top line indicates the upper and the lower alarm limits for %SpO₂ and for the pulse rate (PR). In the example above, the lower alarm limit for %SpO₂ is 70% and the upper alarm limit is 100%. Pulse Rate alarm limits are 60 BPM (lower), and 160 BPM (upper).

Monitor Status

N-600x	VERSION X.X.X.X	CRC: XXXX	SpO2 Limit: 70-100%	PR Limit: 60-160BPM
	ADULT	OSAT-S	SPO2 RESP MODE: NORMAL	
TIME	%SpO2	BPM	PA	Status

The monitor status, ADULT or NEO (Neonate), is displayed on the second line of the heading.

Column Headings

N-600x	VERSION X.X.X.X	CRC: XXXX	SpO2 Limit: 70-100%	PR Limit: 60-160BPM
	ADULT	OSAT-S	SPO2 RESP MODE: NORMAL	
TIME	%SpO2	BPM	PA	Status

Actual column headings are in the second row of the column heading. Patient data presented in the chart, from left to right, is the time that the line was obtained, the current %SpO₂ value being measured, the current Pulse Rate in BPM's, the current Pulse Amplitude (PA), and the operating status of the monitor.

Patient Data and Operating Status

Time

TIME		%SpO2	BPM	PA	Status
01-JAN-06	14:00:05	100	190*	50	

The Time column represents the monitor's real-time clock.

Patient Data

N-600x VERSION X.X.X.X CRC: XXXX SpO2 Limit: 70-100% PR Limit: 60-160BPM					
ADULT		OSAT-S	SPO2 RESP MODE: NORMAL		
TIME		%SpO2	BPM	PA	Status
01-JAN-06	14:00:05	100	*190	50	

Patient data and the operating status of the unit are highlighted in the display above. Parameter values, at the time of the printout, are displayed directly beneath the heading for each parameter. In this example the %SpO₂ is 100, and the pulse rate (BPM) is 190 beats per minute. The asterisk (*) next to the 190 indicates that 190 beats per minute is outside of the alarm limits, indicated in the top row, for pulse rate. If no data for a parameter is available, three dashes [- - -] display on the printout.

Pulse Amplitude (PA) can range from 0 to 254. There are no alarm parameters for this value. It can be used for trending information and is an indication of a change in pulse volume, pulse strength, or circulation.

Operating Status

N-600x VERSION X.X.X.X CRC: XXXX SpO2 Limit: 70-100% PR Limit: 60-160BPM					
ADULT		OSAT-S	SPO2 RESP MODE: NORMAL		
TIME		%SpO2	BPM	PA	Status
01-JAN-06	14:00:05	100	*190	50	PH

The Status column indicates alarm conditions and operating status of the *N-600x*. In this example, PH refers to Pulse High. The status codes are listed in Table 22. As many as four codes can be displayed simultaneously in the Status column.

Table 22: Operating Status Codes

Code	Meaning
AO	Alarm Off
AS	Alarm Silence
BU	Battery in Use
LB	Low Battery
LM	Loss of Pulse with Interference
LP	Loss of Pulse
MO	Interference Detected
PH	Pulse Rate Upper Limit Alarm
PL	Pulse Rate Lower Limit Alarm

Table 22: Operating Status Codes

Code	Meaning
PS	Pulse Search
SD	Sensor Disconnect
SH	Saturation Upper Limit Alarm
SL	Saturation Lower Limit Alarm
- - -	No Data Available
*	Alarm Parameter Being Violated



Note: A Sensor Disconnect can cause three dashes [- - -] to display in the patient data section of the printout.

Trend Data Printout (ASCII Mode)

The format of data displayed when a trend printout is requested is similar to that of the real-time data. The only differences are that “TREND” is displayed in the top row instead of the “CRC:XXXX” software verification number, and there is no “Status” column (Figure 18).

Readings are displayed in 2-second intervals. The values on each row are an average for the 2-second period.

At the end of the printout, an “Output Complete” line indicates the transmission was successful. If the “Output Complete” line is not present, the data should be considered invalid.

N-600x	VERSION X.X.X.X	TREND	SpO2 Limit: 70-100% PR Limit: 60-160BPM	
	ADULT	OSAT-S	SPO2 RESP MODE: NORMAL	
TIME		%SpO2	BPM	PA
01-JAN-06	14:00:05	100	120	150
01-JAN-06	14:00:09	100	121	154
01-JAN-06	14:00:13	100	120	150
Output Complete				

Figure 18: Trend Data Printout (ASCII Mode)

Trend Printout (Graph Mode)

The Graph mode (Figure 19 and Figure 20) disables all printout functions except trend data. Trend printouts are graphical if connected to a serial printer that supports Epson ESC protocol.

To print in the Graph mode, the monitor protocol must be changed to Graph. See *Communication Protocol* on page 129.

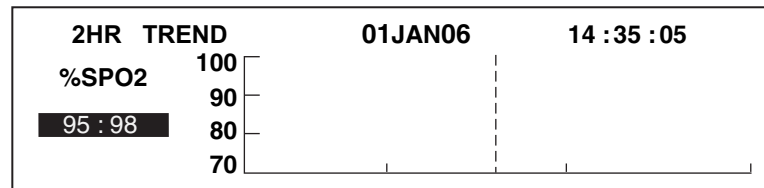

Figure 19: Monitor Trend Data Printout (Graph Mode)

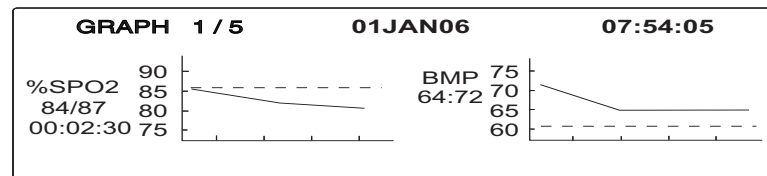

Figure 20: Sensor Event Record Printout (Graph Mode)

Nurse Call

An RS-232 Nurse Call signal (pins 5 and 11) can be obtained by connecting to the data port. It is in the form of a positive or negative voltage chosen by the user.

The remote location will be signaled anytime there is an audible alarm. If the audible alarm has been set to Off or silenced, the Nurse Call function is also turned off.

Pin 11 on the data port is the RS-232 Nurse Call signal and pin 5 is ground (Table 23). When there is no audible alarm, the voltage between pins 10 and 11 are -5 VDC to -12 VDC, or +5V DC to +12 VDC, depending on the option chosen via the softkeys (either NORM+ or NORM-). Whenever there is an audible alarm, the output between pins 5 and 11 will reverse polarity.

An internal Nurse Call relay (pins 7, 8, and 15) provides dry contacts that can be used to signal a remote alarm. Pin 15 is common, pin 7 is normally open (N.O.), and pin 8 is normally closed (N.C.). Table 23 shows the state of the contacts for

alarm and no alarm conditions, and for instrument off. Table 24 defines the ratings of the Nurse Call Relay.

Table 23: Nurse Call Relay Pin States

Pin	No Alarm or Alarm Silenced	Audible Alarm	Instrument Off
7 N.O.	Open	Closed	Closed
8 N.C.	Closed	Open	Open

Table 24: Rating of Nurse Call Relay

Maximum Input Voltage	30 VA or DC (polarity is not important)
Load Current	120 mA continuous (peak 300 mA @ 100 ms)
Minimum Resistance	26.5 ohms to 50.5 ohms (40.5 ohms typical) during alarms
Ground Reference	Isolated Ground
Electrical Isolation	1500 Volts

Analog Output

Analog outputs are provided for Saturation, Pulse Rate, and a Plethysmographic waveform.

The output voltage is 0.0 to +1.0 VDC for all three parameters:

- 1.0 VDC Output for Saturation = 100%
- 1.0 Pulse Rate = 250 BPM
- 1.0 Plethysmographic Waveform = 254 Pulse Amplitude Units.

The voltage decreases as the values for these parameters decrease. If no data for a parameter is available, the output voltage for that parameter is 1.0 VDC.

After the completion of power-on self-test (POST), the instrument initiates an automatic three-step calibration signal. The calibration signal begins at 0.0 VDC and hold that point for 15 seconds. It increases to 1.0 VDC and hold that value for 15 seconds. The third part of the calibration signal is a stair step signal. The stair step signal begins at 0.0 VDC and increase up to 1.0 VDC in 0.1 VDC increments. Each increment is held for 1 second. Through use of the softkeys, the 0.0 VDC, 1.0 VDC, or stair step signal can be selected individually (see *Using the Analog Output* on page 27).

Technical Discussion

Oximetry Overview

The *N-600x* uses pulse oximetry to measure functional oxygen saturation in the blood. Pulse oximetry works by applying an *OxIMAX* sensor to a pulsating arteriolar vascular bed, such as a finger or toe. The *OxIMAX* sensor contains a dual light source and a photo detector.

Bone, tissue, pigmentation, and venous vessels normally absorb a constant amount of light over time. The arteriolar bed normally pulsates and absorbs variable amounts of light during the pulsations. The ratio of light absorbed is translated into a measurement of functional oxygen saturation (%SpO₂).

Since a measurement of %SpO₂ is dependent upon light from the *OxIMAX* sensor, excessive ambient light can interfere with this measurement.

Specific information about ambient conditions, *OxIMAX* sensor application, and patient conditions is contained throughout this manual.

Pulse oximetry is based on two principles; oxyhemoglobin and deoxyhemoglobin. These principles differ in their absorption of red and infrared light (i.e., spectrophotometry), and the volume of arterial blood in tissue (and hence, light absorption by that blood) changes during the pulse (i.e., Plethysmography). A pulse oximeter determines %SpO₂ by passing red and infrared light into an arteriolar bed and measuring changes in light absorption during the pulsatile cycle. Red and infrared low-voltage light-emitting diodes (LED) in the oximetry *OxIMAX* sensor serve as light sources; a photo diode serves as the photo detector.

Since oxyhemoglobin and deoxyhemoglobin differ in light absorption, the amount of red and infrared light absorbed by blood is related to hemoglobin oxygen saturation. The pulse oximeter uses the pulsatile nature of arterial flow to identify the oxygen saturation of arterial hemoglobin. During systole, a new pulse of arterial blood enters the vascular bed, causing both the blood volume and light absorption to increase. During diastole, blood volume and light absorption reach their lowest point. The pulse oximeter bases its %SpO₂ measurements on the difference between maximum and minimum absorption (i.e., measurements at systole and diastole). The oximeter focuses on light absorption by pulsatile arterial blood, eliminating the effects of nonpulsatile absorbers such as tissue, bone, and venous blood.

Functional versus Fractional Saturation

The pulse oximeter measures functional saturation -- oxygenated hemoglobin expressed as a percentage of the hemoglobin that can transport oxygen. It does not detect significant amounts of dysfunctional hemoglobin, such as carboxyhemoglobin or methemoglobin. In contrast, hemoximeters such as the IL482 report fractional saturation -- oxygenated hemoglobin expressed as a percentage of all measured hemoglobin, including measured dysfunctional hemoglobins. To compare functional saturation measurements to those from an instrument that measures fractional saturation, fractional measurements must be converted as follows:

$$\text{functional saturation} = \frac{\text{fractional saturation}}{100 - (\% \text{ carboxyhemoglobin} + \% \text{ methemoglobin})} \times 100$$

Measured versus Calculated Saturation

When saturation is calculated from a blood gas partial pressure of oxygen (PO₂), the calculated value may differ from the %SpO₂ measurement of a pulse oximeter. This usually occurs when the calculated saturation was not appropriately corrected for the effects of variables that shift the relationship between PO₂ and pH, temperature, the partial pressure of carbon dioxide (PCO₂), 2, 3-DPG, and fetal hemoglobin. See Figure 21.

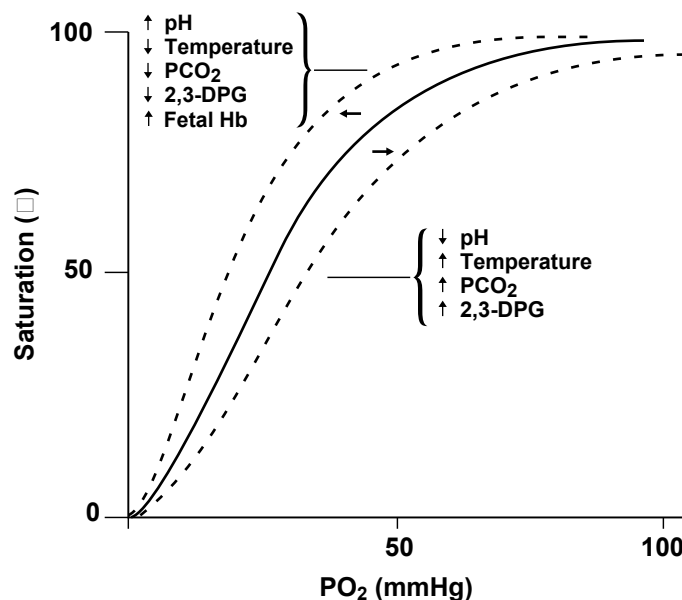

Figure 21: Oxyhemoglobin Dissociation Curve

SatSeconds Alarm Management

The monitor utilizes Nellcor *SatSeconds* alarm management technique. *SatSeconds* is a function of the software within the *N-600x*. With the *SatSeconds* technique, upper and lower alarm limits are set in the same way as traditional alarm management. The clinician also sets a *SatSeconds* limit that allows monitoring of %SpO₂ below the selected lower alarm limit for a period of time before an audible alarm sounds. Refer to the *OxIMAX N-600x Operator's Manual* for managing *SatSeconds*.

Signal Processing

The *OxIMAX N-600x* signal processing uses Cardiac Gated Averaging (CGA) to process the red and IR waveforms. CGA processing attenuates a signal that does not occur synchronously with the average rhythm of the heartbeat. The result is accurate and reliable %SpO₂ and pulse rate values.

OxIMAX Technology

The monitor is designed to use Nellcor brand *OxIMAX* sensors containing *OxIMAX* technology. These *OxIMAX* sensors can be identified by the deep blue and/or white colors of the plugs. All *OxIMAX* sensors contain a memory chip carrying information about the *OxIMAX* sensor which the oximeter needs for correct operation, including the *OxIMAX* sensor's calibration data, model type, troubleshooting codes, and error detection data. This unique oximetry architecture enables several new features.

When an *OxIMAX* sensor is connected to the *N-600x*, the pulse oximeter reads the information in the *OxIMAX* sensor memory chip, checks it to make sure that there are no errors, and then loads the data to begin monitoring. As the pulse oximeter reads the information, it flashes the *OxIMAX* sensor model number on its display. This process may take a few seconds. Once the reading process is complete, the *OxIMAX* sensor model number stops flashing and monitoring begins. The *OxIMAX* sensor model number disappears after the pulse oximeter starts tracking the patient's %SpO₂ and pulse rate.

Pulse Oximeters containing *OxIMAX* technology, including the *N-600x*, use calibration data contained in the *OxIMAX* sensor in calculating the patient's %SpO₂. With *OxIMAX* sensor calibration, the accuracy of many *OxIMAX* sensors can be improved, since the calibration coefficients can be tailored to each *OxIMAX* sensor. Consult the accuracy card included with the pulse oximeter for specific accuracy information for the *N-600x* with different Nellcor approved *OxIMAX* sensors.

The *N-600x* uses the information in the *OxiMAX* sensor to tailor troubleshooting messages for the clinician. The *OxiMAX* sensor contains coding telling the pulse oximeter the type of *OxiMAX* sensor being used. When deciding which messages to display, the pulse oximeter determines the *OxiMAX* sensor type and recommended patient site for each model.

Block Diagram Theory

The monitor block diagram is shown below in Figure 22.

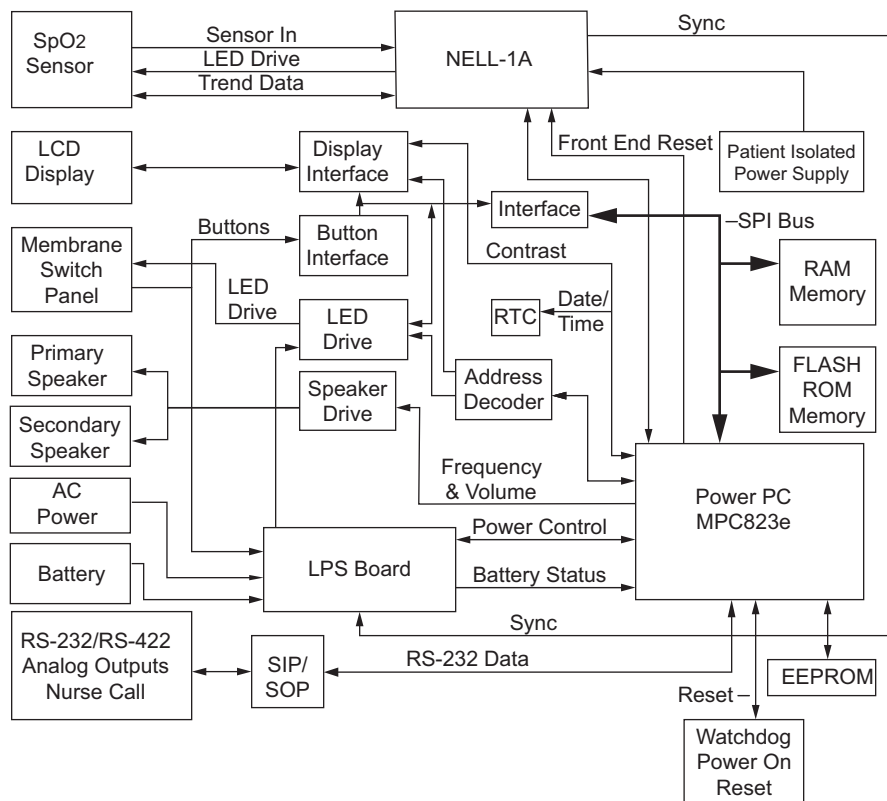

Figure 22: Block Diagram

The N-600x Main Board (PCB) consists of three (3) main parts:

- Secondary Input Port/Secondary Output Port (SIP/SOP)
- NELL-1A Oximetry Module
- User Interface (UIF)

The Secondary Input Port/Secondary Output Port SIP/SOP and the NELL-1A Oximetry Module front end are both electrically isolated from the UIF. The NELL-1A is electrically isolated to reduce capacitive coupling to earth ground and improve the NELL-1A's ability to read difficult patient data. The SIP/SOP is isolated as mandated by regulations for patient safety.

The *N-600x* contains the Motorola MPC823e PowerPC (823e) microprocessor. As shown in the block diagram above, the 823e provides the bulk of the functionality in the instrument, acting as the “master” controller, while NELL-1A Oximetry Module handles the pulse oximetry functions and the Linear Power Supply (LPS) board microcontroller handles the AC/Battery power management tasks. Communications between the *N-600x* board and the Nell-1A module takes place over an asynchronous isolated bidirectional serial link. The microprocessor receives messages from the NELL-1A and extracts status, %SpO₂ and pulse rates.

Communication with the LPS board takes place over a non-isolated bidirectional serial link. The microcontroller receives periodic status information that it uses to act on power supply stat.

High speed SRAM and Flash ROM are provided for the 823e microprocessor on the circuit board. Low speed SRAM is used to hold infrequently used data, primarily trend data.

The primary responsibilities of the 823e are as follows:

- Processing of the oximetry data
- Display of the %SpO₂ and pulse rate data, and all other display data including status LEDs on the membrane panel
- User Interface
- Serial port communication through the SIP/SOP interface
- Nurse call outputs
- Analog outputs
- Sound generation by generating the appropriate volume and frequency control settings for the speaker circuitry
- Monitoring and controlling instrument power
- Communicating with the real-time clock (RTC) and electrically-erasable-programmable-read-only-memory (EEPROM)
- Trend data collection and storage

Static random-access-memory (RAM) and FLASH read-only memory (ROM) are provided for the microprocessor on the PCB. The system monitor resets the entire PCB if the +3.3 volts is out of tolerance or the watchdog timer is not periodically reset by the software.

Power is supplied to the *N-600x* either from an AC connection (100-120 or 200-240 VAC) or from a 6-volt, 4 ampere-hour battery. The transition between power sources is invisible to the user, from AC power to battery power or from battery power to AC power. Power can remain active during cases where AC power is lost or applied. The LPS microcontroller monitors the battery voltage

and shuts off the unit power supply if the battery voltage becomes too low to support *N-600x* functionality. The Patient Isolated power supply for the *N-600x* is an isolated switcher which generates +3.3, +5, and +12 volts. The patient is connected to the *N-600x* via an *OxIMAX* sensor and pulse oximetry cable. The NELL-1A oximetry module drives the *OxIMAX* sensor's LEDs, conditions the incoming signal, and provides adjustable gain status. The oximetry module measures the *OxIMAX* sensor's analog outputs and continually controls the gain stages and LED drive current to ensure the signals are within the measurement range.

The monitor has a 240 x 64 liquid-crystal display (LCD) which provides various display capabilities including numeric readouts for %SpO₂ and beats per minute (BPM) pulse rate, graphical pleth wave and pulse blip bar, menu selection elements, and status/error messages. There is also a membrane panel consisting of nine (9) buttons and five (5) LED indicators. The buttons enable the user to navigate through and input menu selections using the LCD and LED interfaces. The LED indicators provide feedback to the user on various *N-600x* and *OxIMAX* sensor conditions. The monitor contains primary and secondary speakers for audio output.

The static RAM and the RTC for the microprocessor are powered whenever the monitor has power, either AC power or battery power. This allows time and certain data to be maintained, even while the monitor is turned off.

Figure 23: LPS Board Schematic Diagram (Sheet 1 of 1)

Figure 24: Main PCB Schematic Diagram (Sheet 2 of 11)

Figure 25: Main PCB Schematic Diagram (Sheet 2 of 11)

Figure 26: Main PCB Schematic Diagram (Sheet 3 of 11)

Figure 27: Main PCB Schematic Diagram (Sheet 4 of 11)

Figure 28: Main PCB Schematic Diagram (Sheet 5 of 11)

Figure 29: Main PCB Schematic Diagram (Sheet 6 of 11)

Figure 30: Main PCB Schematic Diagram (Sheet 7 of 11)

Figure 31: Main PCB Schematic Diagram (Sheet 8 of 11)

Figure 32: Main PCB Schematic Diagram (Sheet 9 of 11)

Figure 33: Main PCB Schematic Diagram (Sheet 10 of 11)

Figure 34: Main PCB Schematic Diagram (Sheet 11 of 11)

Index

A

Accessories on Internet 10
Adjust Contrast Up, Down 80
Adjusting the Power-On Settings 47
Adult Default Settings 50
Alarm Management, SatSeconds 149
Alarm Off 60
Alarm Range Limits 19
Alarm Silence 23
Alarm Speaker Replacement 99
Alarm Volume Control 25
Alarms Softkey 58
Analog Calibration Setup 133
Analog Output 27, 146
AO 143
AS 143
ASCII Mode 144

B

Battery 13
Battery Cannot Be Fully Charged - Replace Battery 80
Battery Charge 16
Battery Replacement 88
BATTERY Softkey 61
BLIP Display 18
Block Diagram Theory 150
BU 143
Button Problems 66

C

Cables 122
Calculated Saturation 148
Calibration 12
Cautions 3
Cleaning 11
Clock Settings Lost 80
Communicating with a Computer 137

Communication Baud Rate 128
Communication Protocol 129
Configuring the Data Port 127
Connecting to the Data Port 136
Cooling Fan Replacement 93

D

Danish 131
DANSK 131
Data Port Interface Protocol 127
Data Port Pin Layout 136
Data Port Pin Outs 136
Data Port Problems 69
Data Port, Connecting To 136
Data Type
 Event/SpO2 + BPM 80
 SpO2 80
Data-In OXIMAX Sensor 80
Date and Time 138
Datex-Ohmeda Communications 135
Defaults Lost 80
Delete Trend? 80
Deutsch 131
Digital Multimeter 15
Disassembling the Monitor 83
Disinfecting 11
Display PCB Replacement 95
DownId Softkey 58
Dump Error Log 138
Dump Instrument Info 137
Dump Trend 138
Dutch 131

E

Earth Leakage Current Specifications 124
Electromagnetic Emissions 117
Electromagnetic Immunity 117
Electrostatic Immunity
 Portable RF Equipment 119

Enclosure Leakage Current Specifications
124
English 131
Equipment Needed for Performance Checks
15
Errlog Softkey 56
Error Codes 74
Exit Interactive Mode 138
Exit Softkey 52
Exploded View 104
Explosion Hazard 2

F

Factory Default Settings 48
Finnish 131
Fractional Saturation 148
French 131
Front Panel 5
Functional Checks 12
Functional Saturation 148
Fuse Replacement 84

G

GE Marquette Communications 134
German 131
Graph Mode 145
Ground Integrity Specification 124

H

Help
 accessing single topics 72
 multiple topics 70
Help Speaker Failure 80
Hospital Type Environments 4

I

Info Softkey 57
Instat Softkey 56
Instrument Info Dump 137
Introduction 1
Invalid Blip Vol 80
Invalid Silence Duration 80

Invalid SpO2 Limit 80
Italian 131

L

Language Selection 131
LB 143
LED Excitation Test 29
LM 143
Loss of Pulse with Interference 143
Low Battery 80
LP 143

M

Main Board PCB Replacement 97
Main Menu 7
Manufacturer's Declaration 117
Measured Saturation 148
MO 143
Monitor
 Accuracy Tolerance 111
 Measurement Range 111
Monitor Assembly 88
Monitor Description 4
Monitor Disassembly 85

N

Neonate Default Settings 48
Next Softkey 52, 58
Norwegian 131
Nurse Call 26, 145
Nurse Call Relay Pin States 146
Nurse Call Setup 132

O

On-Screen Help 70
Operating
 Altitude 114
 Atmospheric Pressure 114
 Relative Humidity 114
 Temperature 114
Operating Status Codes 143
Operation on Battery Power 29

Operation with a Live Subject 31
Operational Performance Problems 68
OXIMAX Technology 149
Oximetry Overview 147

P

Packing for Shipment 107
Param Softkey 53
Parts List 104
Patient Applied Risk Current 46
Patient Applied Risk Current Specifications 125
Patient Isolation Risk Current 46, 125
Performance Tests 16
Performance Verification 15
Periodic Safety Checks 12
PH 143
Philips Communications 133
Physical Characteristics 115
PL 143
PLETH Display 18
Portuguese 131
Power Entry Module Replacement 90
Power Problems 65
Power Supply Replacement 91
Power-On Defaults 19
Power-On Self-Test 16
Power-On Settings and Service Functions 47
Power-Up Performance 16
Primary Speaker Failure 80, 81
Print Softkey 54
Printout, Real-Time 139
Problem Categories 63
PS 144
Pulse Tone Volume Control 26

R

Reading Trends 80
Real-Time Printout 139
REAL-TIME TREND Display 18
Rear Panel 6
Recommended Separation Distances 121

Related Documents 10
Removing the Alarm Speaker 99
Removing the Cooling Fan 93
Removing the Display PCB 95
Removing the Main Board PCB 97
Removing the Power Entry Module 90
Removing the Power Supply 91
Removing the Top Case Assembly 102
Repacking in a Different Carton 109
Repacking in Original Carton 108
Replacement Level Supported 84
Replacing the Alarm Speaker 101
Replacing the Battery 89
Replacing the Cooling Fan 94
Replacing the Display PCB 96
Replacing the Main Board PCB 98
Replacing the Power Entry Module 91
Replacing the Power Supply 92
Replacing the Top Case Assembly 102
Reset Defaults? 80
Reset Softkey 53
Routine Maintenance 11

S

Safety Analyzer 15
Safety Tests 46
SatSeconds Alarm Management 149
Save Defaults? 80
Save Softkey 53
SD 144
Select Softkey 59
Sensor Disconnected 81
Sensor Power Dissipation 114
Sensor Softkey 53
Service Functions 51
Service Functions, Accessing 51
Setting
 Date and Time 138
Setting Institutional Defaults 60
Settings Lost 81
SH 144
SL 144

Softkey Menu 6
Software Version 17
Spanish 131
Spare 103
Spare Parts 103
Spare Parts on Internet 10
Specifications 111
 Battery 112
 Compliance 115
 Electrical 112
 Electrical,Instrument 112
 Environmental 114
 Performance 111
 Physical 115
Status Code
 Alarm Off 143
 Alarm Silence 143
 Battery in Use 143
 Interference Detected 143
 Loss of Pulse 143
 Loss of Pulse with Interference 143
 Low Battery 143
 Pulse Rate High Limit Alarm 143
 Pulse Rate Low Limit Alarm 143
 Pulse Search 144
 Saturation High Limit Alarm 144
 Saturation Low Limit Alarm 144
 Sensor Disconnect 144
Status Codes 143
Storage
 Relative Humidity 114
 Temperature 114
Surface-Cleaning 11
Swedish 131

Transport
 Altitude 114
 Relative Humidity 114
 Temperature 114
Trend Data Printout (ASCII Mode) 144
Trend Printout (Graph Mode) 145
Trend Softkey 55
Troubleshooting Guide 63

U

Unit Will Shut Down If AC Power Is Lost 81
Using Data on the PC 139

W

Warnings 1
Who Should Perform Repairs 63

T

Technical Discussion 147
Test No. 1
 BPM 33
Test No. 2
 SpO2 35
Test No. 3
 Modulation Level 37
Test No. 4
 Light 41

Rx
ONLY



CE
0123

Part No. 10071092 Rev. A

COVIDIEN, COVIDIEN with logo and Covidien logo are U.S.
and/or internationally registered trademarks of Covidien AG.

™* Trademark of its respective owner.
Other brands are trademarks of a Covidien company.

©2011 Covidien.

 Covidien Inc,
15 Hampshire Street, Mansfield, MA 02048 USA.
 Covidien Ireland Limited,
IDA Business & Technology Park, Tullamore.

www.covidien.com

[T] 1-800-635-5267